

1 MANUAL FOR PROFORT MULTI GUARD

GSM/LAN UNITS 3

1.1 SPECIFICATIONS WALL-MOUNTED BOXES	3
1.2 FUNCTIONS WALL-MOUNTED BOXES	5
1.3 SPECIFICATIONS DIN/MOUNTING BOXES	6
1.4 FUNCTIONS DIN/MOUNTING BOXES	8
1.5 DESCRIPTION	11
1.6 SYSTEMS ILLUSTRATION	14

2 MOUNTING 15

2.1 PREPARE THE UNIT	15
2.2 ELECTRIC MOUNTING	15
2.3 INSTALLING A SIM CARD (NOT APPLICABLE FOR MODEL REMOTE LAN)	21
2.4 CONNECT GSM UNIT	21
2.5 CONNECT LAN UNIT	21

3 PREPARING THE PC 23

3.1 MINIMUM REQUIREMENTS FOR THE PC	23
3.2 FINDING COM NO.	23

4 INSTALLATION OF THE PROFORT PC PROGRAM 25

5 SET-UP ON PC 26

5.1 START SET-UP	26
5.2 SETTINGS	27
5.3 FILL IN THE SETTINGS	27
5.4 MAIN PAGE	28
5.5 TAB: MODEM (M)	30
5.5.1 CENTRALENHED (M1)	31
5.5.2 RECEIVERS (M2)	31
5.5.3 SETUP (M3)	33
5.6 TAB: INPUTS (I)	34
5.6.1 COMMANDS IN THE TEXT FIELD	37
5.7 TAB: OUTPUTS (O)	39
5.8 TAB: CALENDAR (C)	41
5.9 TAB: WIRELESS (W)	42
5.9.1 COMMAND EXECUTION IN TEXT FIELD	46
5.10 TAB: MORE(V)	47

6 SET-UP ON MASTERVIEW 50

6.1 CREATE USER	50
6.2 LOG IND	51
6.3 CREATE A UNIT	51

6.4 RETRIEVE SETUP FROM THE UNIT	53
----------------------------------	----

6.5 CONNECT TO EXISTING DEVICE	53
--------------------------------	----

6.6 RETRIEVE A TEMPLATE	53
-------------------------	----

6.7 CHANGE THE SETUP	54
----------------------	----

6.7.1 RECEIVER	54
----------------	----

6.7.2 DIGITAL INPUTS	55
----------------------	----

6.7.3 ANALOGUE INPUTS	56
-----------------------	----

6.7.4 OUTPUTS	56
---------------	----

6.7.5 CALENDAR	56
----------------	----

6.7.6 WIRELESS	57
----------------	----

6.7.7 MACROS	57
--------------	----

6.7.8 OTHER	58
-------------	----

6.8 SAVE AS TEMPLATE	58
----------------------	----

6.9 OPERATION	58
---------------	----

7 SET-UP VIA DISPLAY 60

7.1 ACCESS TO THE UNIT	61
------------------------	----

7.2 ADD NAME IN DISPLAY	62
-------------------------	----

7.3 SET-UP	62
------------	----

7.3.1 SET CLOCK	62
-----------------	----

7.4 RESET ALARM	62
-----------------	----

7.5 HANDLING DETECTORS AND REPEATERS	63
--------------------------------------	----

7.5.1 CREATE A DETECTOR OR REPEATER	63
-------------------------------------	----

7.5.2 INTERRUPT WITHOUT UPDATING	63
----------------------------------	----

7.5.3 EDIT DETECTOR INFORMATION	63
---------------------------------	----

7.5.4 DELETE A DETECTOR	64
-------------------------	----

7.6 MONITOR DETECTORS	64
-----------------------	----

8 USE THE COMMANDS 65

9 SET-UP WITH (SMS/TEXT-MESSAGE)

COMMANDS 67

9.1 PASSWORD AND ID	67
---------------------	----

9.2 RECEIVERS	67
---------------	----

9.3 INPUTS	69
------------	----

9.3.1 DIGITAL INPUT	69
---------------------	----

9.3.2 ANALOGUE INPUT	70
----------------------	----

9.3.3 COMMON FOR DIGITAL AND ANALOGUE INPUTS	71
--	----

9.4 OUTPUTS	73
-------------	----

9.5 VOLTAGE	74
-------------	----

9.6 WIRELESS DETECTORS	74
------------------------	----

9.7 MACRO WITH COMMANDS OR INFRARED	77
-------------------------------------	----

9.8 INTERNET	78
--------------	----

9.9 TIME FEATURES AND CLOCK FUNCTIONS	78
---------------------------------------	----

9.10 SYSTEM MESSAGES AND –ALARMS	81
----------------------------------	----

9.11 RESTORE FACTORY SETTINGS	83
-------------------------------	----







<u>10 OPERATION</u>	84
10.1 CONNECTION AND DISCONNECTION OF THE UNIT	
84	
10.2 CONTROL OF RELAY OUTPUTS	85
10.3 INTERRUPT FURTHER ALARMS	85
10.4 INQUIRIES AND COMMANDS TO THE UNIT	86
10.5 MACRO EXECUTION	88
10.6 TEXT TO AND FROM A SERIAL PORT (RS-232)	88
10.7 GPS	89
<u>11 INTERNET</u>	90
<u>12 COMMANDS IN ALPHABETICAL ORDER</u>	91
<u>13 VOICE MESSAGES</u>	97
13.1 RECORD VOICE MESSAGE	97
13.2 DURATION OF VOICE MESSAGES	98
<u>14 LOG</u>	99
14.1 EVENT LOG	99
14.2 DATA LOG	101
<u>15 IR CODES</u>	103
<u>16 FREQUENTLY ASKED QUESTIONS</u>	106

1 MANUAL FOR PROFORT MULTIGUARD GSM/LAN UNITS

This manual applies to the Profort GSM units.

Since the manual contains specifications for units you will not need information on, you can find the specifications and functions of your particular unit in the overview table below.

1.1 Specifications wall-mounted boxes

SPECIFICATIONS						
	myHome	myHome Alarm	Remote IO	Remote LAN	Technic IO	Technic RF
	IR remote control 	IR remote control 	IR remote control 	IR remote control LAN 	Technic 	Technic RF 
Dimension						
Design	Design box White	Design box White	Design box Grey	Design box Grey	Design box Black	Design box Black
Size (mm)	79x49x19	130x80x25	130x80x25	130x80x25	130x80x25	130x80x25
Weight (gram)	52	125	125	125	125	125
Power supply						
Net	5 V DC 1000mA (inclusive)	12 V DC 1,4 A (inclusive)	12 V DC 1,4 A (inclusive)	5 V DC 1,2 A (inclusive)	12 V DC 1,4 A (inclusive)	12 V DC 1,4 A (inclusive)
Battery	3,6 V rechargeable (inclusive)	3,6 V rechargeable (inclusive)	3,6 V rechargeable (inclusive)	÷	3,6 V rechargeable (inclusive)	3,6 V rechargeable (inclusive)
10 V/DC outlet	÷	12V	12V	÷	12V	12V
Consumption, approx. standby	30 mA	30 mA	30 mA	30 mA	30 mA	35 mA
Reloading with battery	150 mA	150 mA	150 mA		150 mA	150 mA
Emergency operation	÷	÷	÷		÷	÷
Emergency supply	With battery	With battery	With battery	÷	With battery	With battery
GSM						
	Inner	Inner	Inner	÷	Inner	Inner
Temperature						
	÷20-55 °C	÷20-55 °C	÷20-55 °C	÷20-55 °C	÷20-55 °C	÷20-55 °C
Digital input						
• Max. 1V, 2 mA (GND)	÷	÷	3	3	3	3
• Min. 18 V maks. 30 V (24 V DC)	÷	÷	3	3	3	3
Close (NC) / open (NO)	÷	÷	✓	✓	✓	✓
Gnd/24V DC	÷	÷	GND	GND	GND	GND
Galvanic separation by. 230VAC	÷	÷	÷	÷	÷	÷
Analogue input						
• 0-10 V	÷	Built-in temperature-sensor	1+built-in temperature-sensor	1+built-in temperature-sensor	1 + Profort PTC input + probe input	1 + Profort PTC input + probe input
• 0/4-20 mA						
• PT100						
• Profort temperature-sensor						
• As digital input						

Manual for Profort multiGuard GSM/LAN units

Relay output						
Number of	÷	÷	1	1	2	2
Max. ampere by 230VAC +35VDC	÷	÷	6	6	6	6

Communication						
GSM-modem (2G)	✓	✓	✓	÷	✓	✓
Ethernet RJ45	÷	÷	÷	✓	÷	÷
Wireless interface (868 MHz)	÷	÷	÷	÷	÷	✓
Wireless digital sensor, up to no. of	÷	÷	÷	÷	÷	60
Wireless analogue sensor, up to no. of	÷	÷	÷	÷	÷	16
Modbus	÷	÷	÷	÷	÷	÷

Infrared						
Sender	2	2	2	2	÷	÷
External sender	1 optional	1 optional	1 optional	1 optional	÷	÷
Receiver	÷	1	1	1	÷	÷







Display						
	÷	÷	÷	÷	÷	÷

Sound						
Internal audio	÷	✓	✓	÷	✓	✓
Siren (Extra loud alarm tone on internal sounder)	÷	✓	✓	✓	✓	✓







Memory for voice						
	÷	÷	÷	÷	÷	÷

Profort pc-program						
RS232 (9 pol.)	÷	÷	✓	✓	✓	✓
Setup	available on web	available on web	available on web	available on web	available on web	available on web
WEB software http://setup.masterview.dk	✓	✓	✓	✓	✓	✓

1.2 Functions wall-mounted boxes

FUNCTIONS						
						
Receiver of alarms						
Number of	25	25	25	25	25	25
Receive as:				e-mail and RS232 over the internet		
<ul style="list-style-type: none"> Text message e-mail (depending on operator) over the internet calls with DTMF-tones via RS232-port to a computer 	✓	✓	✓		✓	✓
• SIA-IP protocol	✓	✓	✓	÷	✓	✓
• Voice message	÷	÷	÷	÷	÷	÷
• On the unit display	÷	÷	÷	÷	÷	÷
Control of outputs						
<ul style="list-style-type: none"> Remote control with text messages, internet and DTMF Automatic activation by alarm on input (from 10 secs. to 15 mins.) Automatic activationaktivering by output follows input Predetermined by timer Predetermined by calender Via macros and commands in text (simple PLC-functions) Via the Profort web server and App for smartphones 	÷	÷	✓	✓ Not text message and DTMF	✓	✓
Macro						
Number of	20	20	20	10	20	20
For commands	✓	✓	✓	✓	✓	✓
For IR codes	✓	✓	✓	✓	÷	÷
USB/AUX connection						
GPS	÷	✓	✓	✓	✓	✓
Temp./humidity sensor	÷	÷	÷	✓	✓	✓
Security						
Password	✓	✓	✓	÷	✓	✓
Accepted user(s) (up to 25)	✓	✓	✓	÷	✓	✓
User password for display	÷	÷	÷	÷	÷	÷
Log						
Alarm log, (events + commands)	256	256	256	256	256	256
Climate log, (measurements 2 x per hour)	24.576	24.576	24.576	24.576	24.576	24.576
Import and export to .csv-file						
Climate log, export	✓	✓	✓	✓	✓	✓
IR codes, import and export	✓	✓	✓	✓	÷	÷
Programming						
Profort pc-program – via RS232 and internet/WEB	Internet/ WEB	Internet/WEB	✓	✓	✓	✓
Text messages	✓	✓	✓	÷	✓	✓
Display	÷	÷	÷	÷	÷	÷

1.3 Specifications DIN/Mounting boxes

SPECIFICATIONS						
	DIN4	DIN6	DIN9	MASTER IO	MASTER RF	Piccolo Light
	4-modules 	6-modules 	9-modules 	Water proof 	Water proof 	Water proof 
Dimension						
Design	DIN 4 modules	DIN 6 modules	DIN 9 modules	IP-65-kasse	IP65 box	IP65 box
Size (mm)	69x86x57	114x86x57	157x86x57	225x200x75	225x200x75	225x200x75
Weight (gram)	125	290	360	1400	1600	1400+300

Power supply						
Net *) For AC power supply, control current must not have potential to ground!	12-24 V AC/DC min 0,5 A*	230 V AC min. 0,1 A 12-24 V AC/DC min 0,5A*	230 V AC min. 0,1 A 12-24 V AC/DC min 0,5A*	230 V AC min. 0,1 A 12-24 V AC/DC min 0,5A*	230 V AC min. 0,1 A 12-24 V AC/DC min 0,5A*	230 V AC min. 0,1 A 12-24 V AC/DC min 0,5A*
Battery	3,6V rechargeable	9V rechargeable t	9V rechargeable	9V rechargeable	9V rechargeable	9V rechargeable
10 V/DC outlet	÷	Max. 100 mA	Max. 100 mA	Max. 100 mA	Max. 100 mA	Max. 100 mA
Consumption, approx. standby reloading with battery	30 mA 5 W	30 mA 5 W	30 mA 5 W	100 mA 5 W	100 mA 5 W	100 mA 5 W
Emergency operation	2 mA					
Emergency supply	48 hrs. with battery	30 mins. with battery	30 mins. with battery	30 mins. with battery	5 mins. with battery	5 mins. with battery

Antenna						
Internal, external option	✓	✓	✓	✓	✓	✓

Temperatur						
	±20-55 °C	±20-55 °C	±20-55 °C	±20-55 °C	±20-55 °C	±20-55 °C

Digital input						
<ul style="list-style-type: none"> Max. 1V, 2 mA (GND) Min. 18 V max. 30 V (24 V DC) 	3	4	8	8	8	8
Close (NC) / open (NO)	✓	✓	✓	✓	✓	✓
Gnd/24V DC	✓	✓	✓	✓	✓	✓
Galvanic separation by. 230VAC	÷	✓	✓	✓	✓	✓

Analogue input						
<ul style="list-style-type: none"> 0-10 V 0/4-20 mA PT100 Profort temperature probe As digital input 	1	1	2	4	4	4

Relay output						
Number of	1	2	4	8	8	8

Manual for Profort multiGuard GSM/LAN units

Max. ampere by 230VAC +35VDC	6	6	6	6	6	6
------------------------------	---	---	---	---	---	---

Communication						
GSM/UTMS-modem	2G	2G+3G	2G+ 3G	2G+ 3G	2G+ 3G	2G + 3G
Ethernet RJ45	÷	÷	÷	÷	÷	Optional
Wireless interface (868 MHz)	÷	÷	÷	÷)	✓	✓
Wireless digital sensor, up to no. of	÷	÷	÷	÷	128	128
Wireless analogue sensor, up to no. of	÷	÷	÷	÷	32	32
Modbus	÷	✓	✓	✓	✓	✓

Infrared						
Sender	÷	÷	÷	÷	÷	÷
External sender	÷	1 optional	÷	÷	÷	÷
Receiver	÷	÷	÷	÷	÷	÷







Display						
	÷	÷	÷	(optional, external)	Built-in	External

Sound						
Internal audio	✓	✓	✓	✓	✓	✓
Siren	÷	÷	÷	✓	✓	✓

Memory for voice						
	÷	÷	90 secs.	÷	÷	÷

Profort pc-program						
RS232 (9 pol.)	✓	✓	✓	✓	✓	✓
Setup	available on web	available on web	available on web	available on web	available on web	available on web
WEB software http://setup.masterview.dk	✓	✓	✓	✓	✓	✓

1.4 Functions DIN/Mounting boxes

FUNCTIONS						
						
Receiver of alarms						
Number of	25	25	25	25	25	25
Receive as:						
<ul style="list-style-type: none"> Text messages e-mail (dep. on operator) over the internet calls with DTMF via RS232-port 	✓	✓	✓	✓	✓	✓
<ul style="list-style-type: none"> SIA-IP protocol 	✓	✓	✓	✓	✓	✓
<ul style="list-style-type: none"> Voice messages 	÷	÷	✓	÷	÷	÷
<ul style="list-style-type: none"> On the unit display 	÷	÷	÷	Optional	✓	✓
Control of outputs						
<ul style="list-style-type: none"> Remote control with text messages, Internet, and DTMF Automatic activation by alarm on input (from 10 sec. till 15 min.) Automatic activation by output follows input Predetermined by timer Predetermined by calendar Via macros and commands in text (simple PLC-functions) Via the Profort web server and app for smartphones 	✓	✓	✓	✓	✓	✓
Macro						
Number of	20	20	20	20	20	20
For commands	✓	✓	✓	✓	✓	✓
For IR codes	÷	✓	÷	÷	÷	÷
USB/AUX connection						
GPS	✓	✓	✓	✓	✓	✓
Temp./humidity sensor	✓	✓	✓	✓	✓	✓
Security						
Password	✓	✓	✓	✓	✓	✓
Accepted user(s) (up to 25)	✓	✓	✓	✓	✓	✓
User password for the display	÷	÷	÷	Optional	✓	✓
Log						
Alarm log (events + commands)	256	256	256	1.000	1.000	1.000
Climate log (measurements 2 x per hour)	24.576	24.576	24.576	150.000	150.000	150.000
Import and export to .csv-file						
Climate log, export	✓	✓	✓	✓	✓	✓
IR codes, import and export	÷	✓	÷	÷	÷	÷



Manual for Profort multiGuard GSM/LAN units

Programming						
Profort pc-program – via RS232 and internet/WEB	✓	✓	✓	✓	✓	✓
Text message	✓	✓	✓	✓	✓	✓
Display	÷	÷	÷	Optional	✓	✓

Functions and facilities	
Alarm	
•	<ul style="list-style-type: none"> • Automatic alarm in case of sabotage and power failure (also in disconnected state) • Wait for 30 sec. before alarm is triggered (burglary alarm) • Also alarm to the latest user • Easy to change order of receivers • Calls three times to same recipient in case of no response (voice call and DTMF) • Acknowledgement of alarm by pressing # immediately after playing the voice message and hearing the sound of the 'beep'. (Whereby the call list will be interrupted)
Input	
•	<ul style="list-style-type: none"> • Input for counting: Input 1 for pulse or minutes. Input 2 + 3 for level or pulse. Max. 20 Hz og 1-999.999 pulse/minutes. • Variable filter time for inputs: 10 sec. to 64 hours • Input 0 for connecting/disconnecting, optionally with message to receiver. Level or pulse. • Command execution in texts (simple PLC functions) • Synchronisation of outputs if change of value and in case of power failure
Time	
•	<ul style="list-style-type: none"> • Automatic or manual setting of the clock • Time-based connection/disconnection • Timer function (with repeat) • Control of status messages • Status with intervals of minutes, daily, or weekly (Wednesday) • Indication of time in log • Calendar function: up to 36 activities by date/daily/weekly
More	
•	<ul style="list-style-type: none"> • Division of alarms into eight zones (areas), e.g. different for open and close • Pre-programmed IR codes for heat pumps • Set-up with PC program via RS232 or GPRS/internet, Profort server and WEB portal http://.setup.masterview.dk • Surveillance via the Profort web portal and Android/iPhone app/Windows WEB • Data communication e.g. with PLC via RS 232 • Macros for execution of more commands simultaneously • Scaling of analogue inputs for relevant measurement (0-10V/4-20mA)

Manual for Profort multiGuard GSM/LAN units

Examples of accessories:

	Profort no. 007995	Temperature probe
	Cf. Profort product catalogue	Wireless alarms, temperature- and humidity probes
	Profort no. 004745	RS-485-module for external receivers
	Profort no. 008210	GPS with 2 m wire. USB connector
	Profort no. 369007	Disc antenna
	Profort no. 300301	9V rechargeable battery
	Profort no. 009010	3,6V rechargeable li-ion battery
	Profort no. 300102	12 V DC power supply
	Profort no. 369003	External antenna with 2,5 m cable
	Profort no. 006320	Temperature- and humidity sensor, 50cm ($\pm 0,3^{\circ}\text{C}$ and $\pm 2,0\%\text{RH}$)
	Profort no. 009067	IR gooseneck
	Profort no. 007022	Waterproof box – IP-65
	Profort no. 009065	IR extension, 2m

For more accessories see www.profort.com

1.5 Description

Set-up of the units in the multiGuard series can be done in the following ways:

- Profort pc-program via RS232 (can be used if e.g. SIM card is missing)
- Profort pc-program via the Internet via the Profort server and GPRS on SIM card
- online via browser via the Internet on www.setup.masterview.dk and GPRS on SIM card
- Commands with text messages from a mobile phone
- Commands via display

multiGuard myHome: IR remote control GSM



The unit can play infrared codes for air/air heat pumps. The codes are activated via GSM. Also for monitoring of temperature and humidity through built-in temperature/humidity sensor. The unit contains GSM modem and is able to transfer data and alarms via text message, internet, DTMF or SIA-IP. This model comes with 5V power supply. With internal battery for alarm in case of power failure.

multiGuard myHome Alarm: IR remote control GSM with built-in PIR sensor



The unit can play infrared codes for air/air heat pumps. The codes are activated via GSM. Also for monitoring of temperature, humidity and movement through built-in temperature/humidity sensor and room sensor (PIR). The unit contains GSM modem and is able to transfer data and alarms via text message, internet, DTMF, SIA-IP or cable. This model comes with 12V power supply. With internal battery for alarm in case of power failure.

multiGuard Remote IO: IR remote control GSM



The unit can play infrared codes for air/air heat pumps. The codes are activated via GSM. Also for monitoring and remote control. The unit contains GSM modem and is able to transfer data and alarms via text message, internet, DTMF, SIA-IP or cable. This model contains terminals for 3 digital inputs and 1 analogue universal input as well as 1 output relay. This model comes with 12V power supply and integrated temperature and humidity sensor. With internal battery for alarm in case of power failure.

multiGuard Remote LAN: IR remote control LAN



The unit can play infrared codes for air/air heat pumps. The codes are activated via GSM. Also for monitoring and remote control. The unit is to be connected to a LAN

and communicates via the Profort web-server. This model contains terminals for 3 digital inputs and 1 analogue universal input as well as 1 output relay. It transmits alarms via the internet as e-mail. This model comes with 5V power supply and temperature sensor.

multiGuard Technic IO



For monitoring and remote control of technical installations. This model has terminals for 3 digital inputs and 1 analogue universal input as well as 2 output relays. The unit contains GSM modem and transmits data and alarms via text message, the internet, DTMF, SIA-IP or cable.

multiGuard Technic RF



For monitoring and remote control of external wireless detectors or measuring analogue values. This model has terminals for 3 digital inputs and 1 analogue universal input as well as 2 output relays. The unit contains GSM modem and transmits data and alarms via text message, the internet, DTMF, SIA-IP or cable.

multiGuard DIN4: 4 modules



For monitoring and remote control. The unit contains GSM modem and transfers data and alarms via text messages, e-mail, Internet, DTMF, SIA-IP or cable. 3 inputs + 1 analog + 1 relay.

multiGuard DIN6: 6 modules



For monitoring and remote control. The unit contains GSM modem and transfers data and alarms via text messages, e-mail, Internet, DTMF, SIA-IP or cable. This model has terminals for 4 digital inputs and 1 analogue universal input as well as 2 output relays. The unit controls air-to-air heat pumps by IR codes over external IR transmitter. Contains Modbus interface.

Manual for Profort multiGuard GSM/LAN units

multiGuard DIN9: 9 modules



For monitoring and remote control. The unit contains GSM modem and transfers data and alarms via text messages, e-mail, Internet, DTMF, SIA-IP or cable. I/O and analog.

multiGuard Master IO



For measuring, monitoring and remote control. Can be connected to external display for alarm display, operation and log. The unit contains GSM modem and transfers data and alarms via SIA-IP, text message, the internet or telephone call. I/O.

multiGuard Master RF



For measuring, monitoring and remote control. The unit has a display for alarm display, operation and log as well as a built-in RF module, which receives signals from wireless detectors. The unit contains GSM modem and transfers data and alarms via SIA-IP, text message, the internet or telephone call.

Piccolo Light



For object protection, monitoring and remote control. The unit has an external display for alarm display, operation and log as well as a built-in module, which receives signals from wireless detectors. The unit contains GSM modem and transfers data and alarms via SIA-IP, text message, the internet or telephone call. Also available with LAN interface, so that all setup and alarm are done via the internet.

1.6 Systems illustration

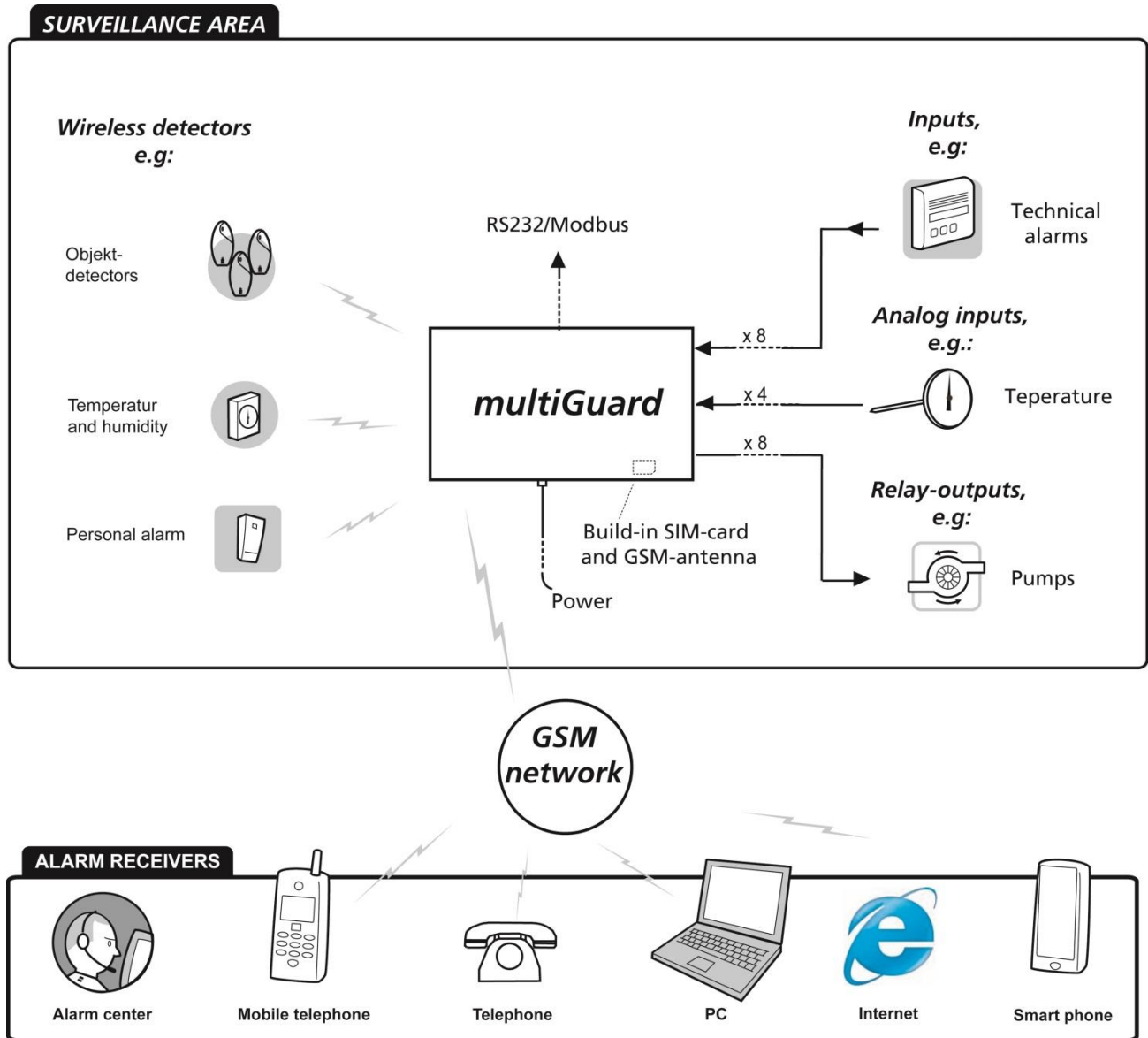

MOUNTING

2 MOUNTING

The unit is mounted on a DIN rail, on a wall, or placed on a table.

In order to obtain optimal signal conditions for GSM and RF signals, Profort a/s recommends:

- Mount the unit vertically and high. The higher it is placed, the better the signals.
- Do not put the unit behind metal, reinforced concrete, massive stone or granite. If this is unavoidable, then use an external GSM antenna.

2.1 Prepare the unit

The unit must be turned off!

Remove the front cover.

2.2 Electric mounting

Figure 2-1

multiGuard myHome:

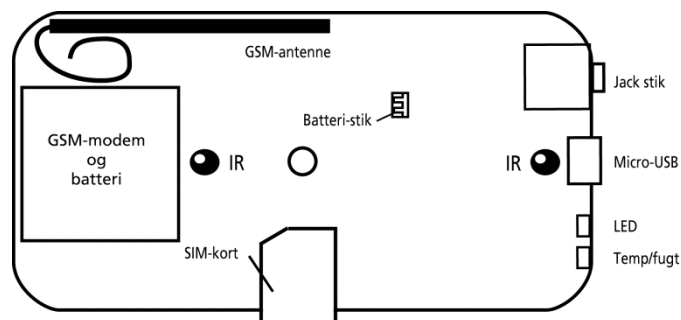

multiGuard myHome Alarm

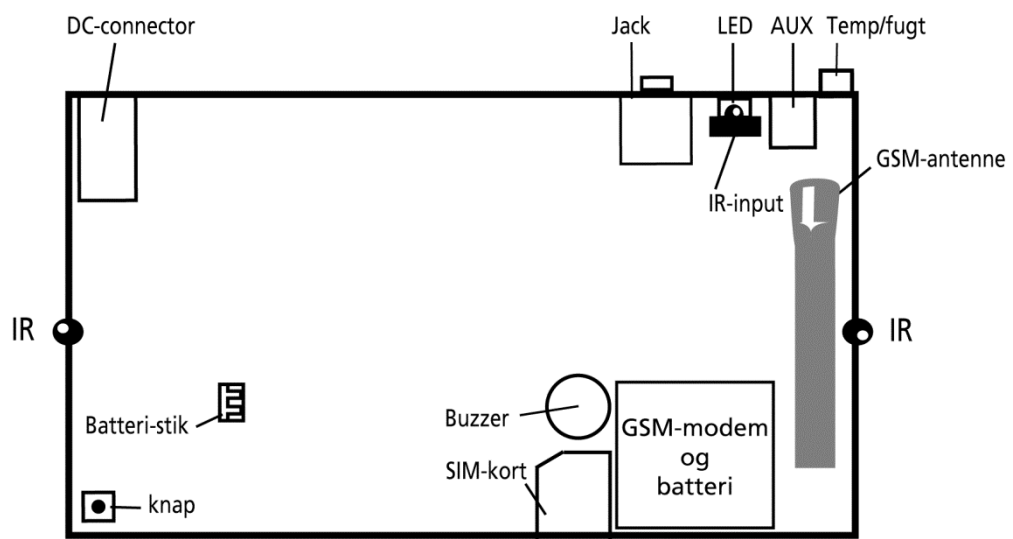

MOUNTING

multiGuard Remote IO

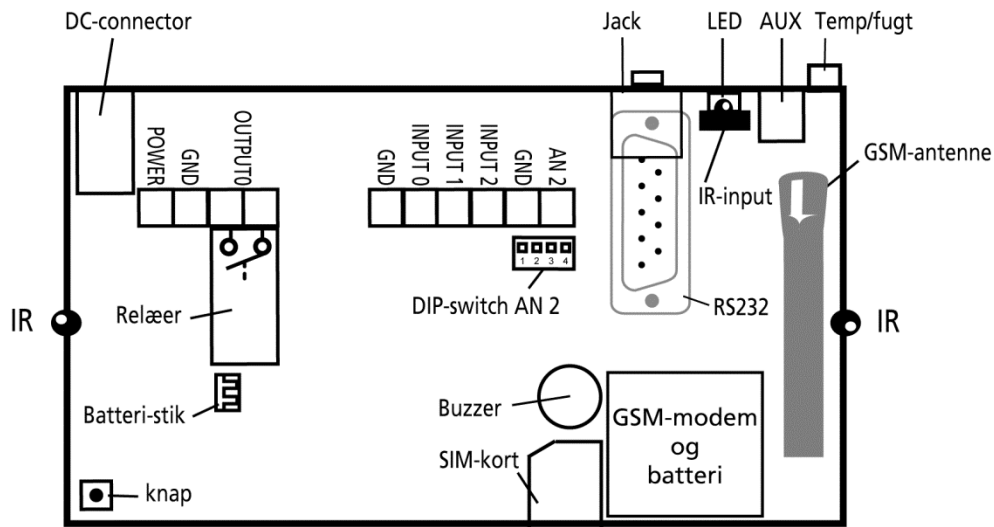

multiGuard Remote LAN

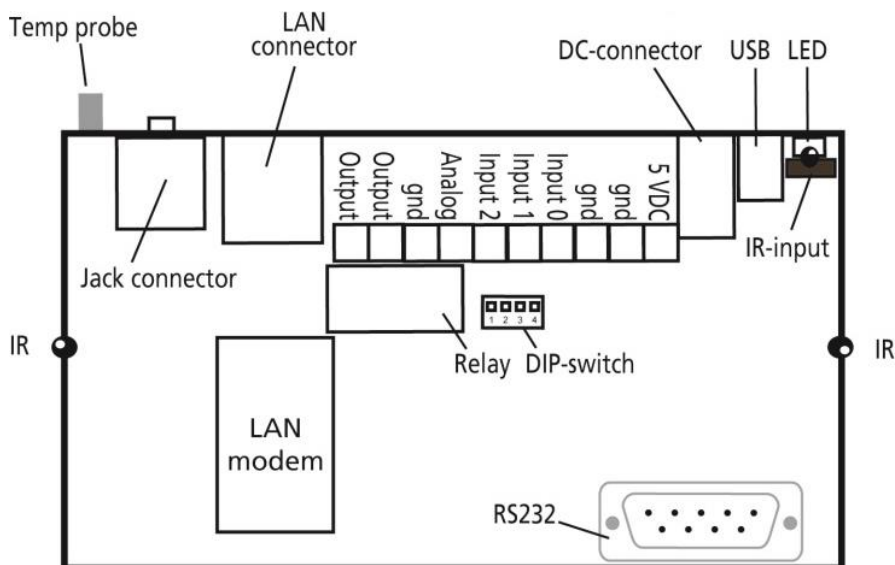

multiGuard Technic IO

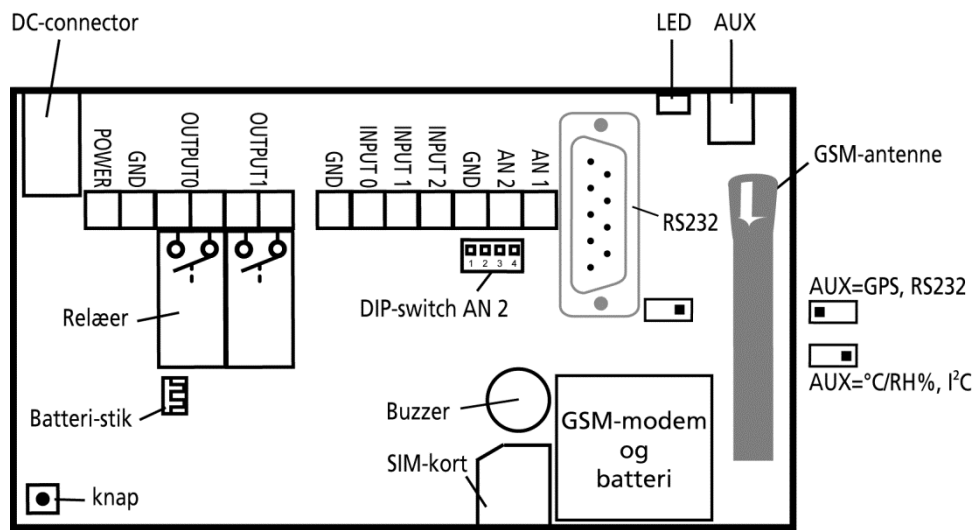

MOUNTING

multiGuard Technic RF

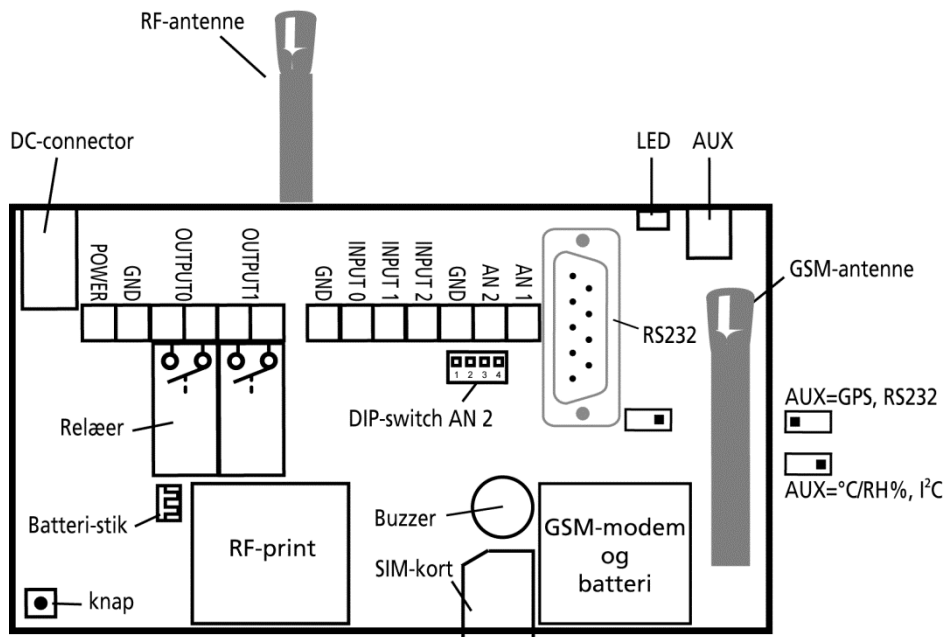

multiGuard DIN4, 4 modules

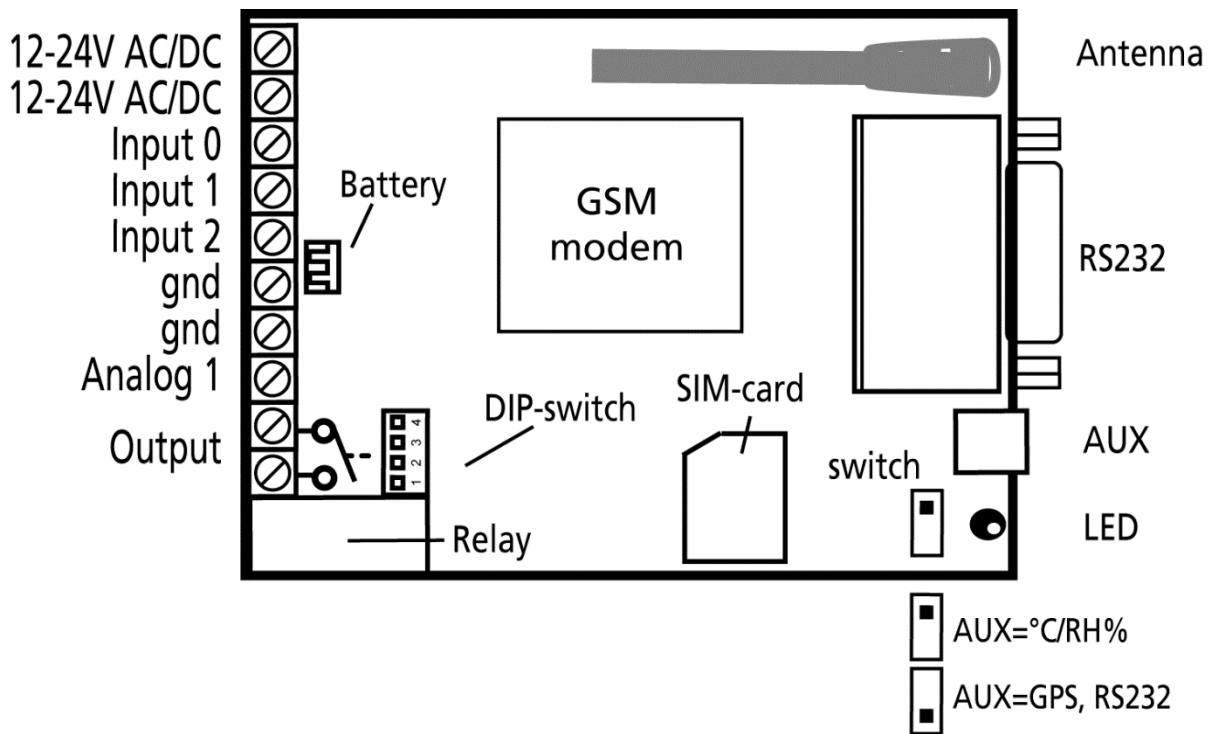

MOUNTING

multiGuard DIN6, 6 modules

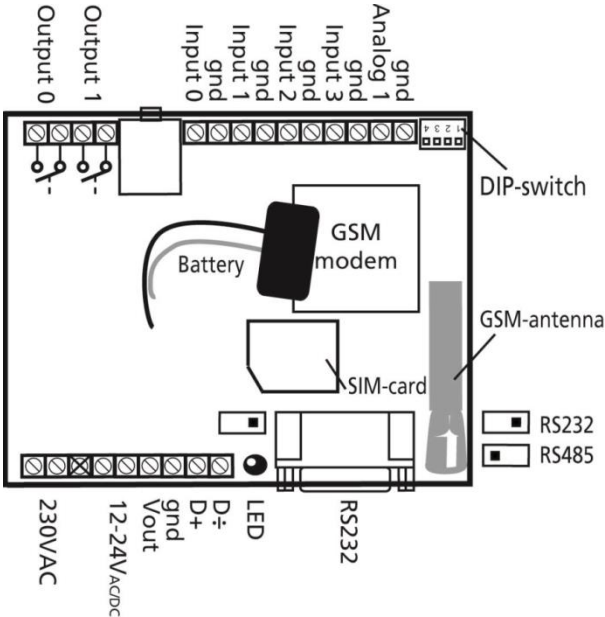

multiGuard DIN9, 9 modules

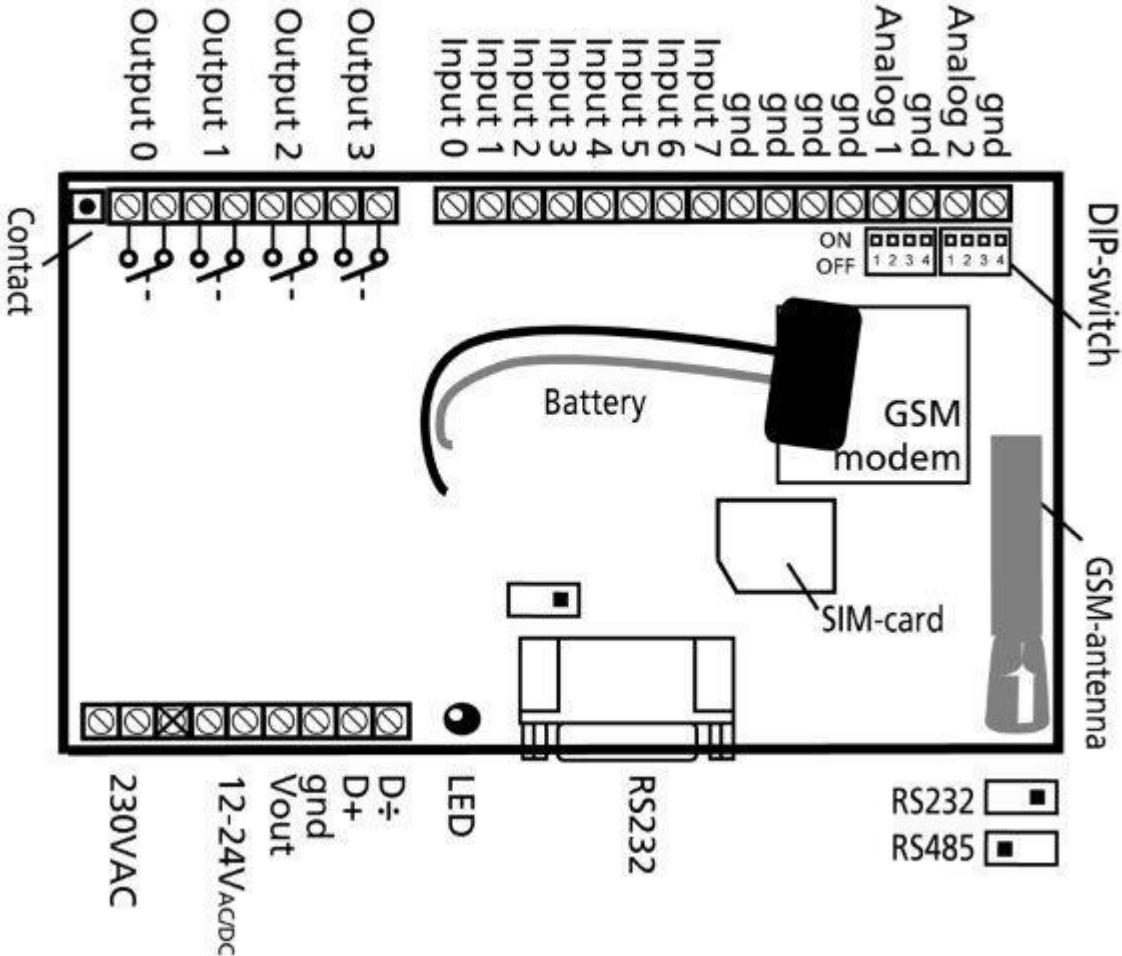

MOUNTING

multiGuard Master IO *) /Master RF/Piccolo Light

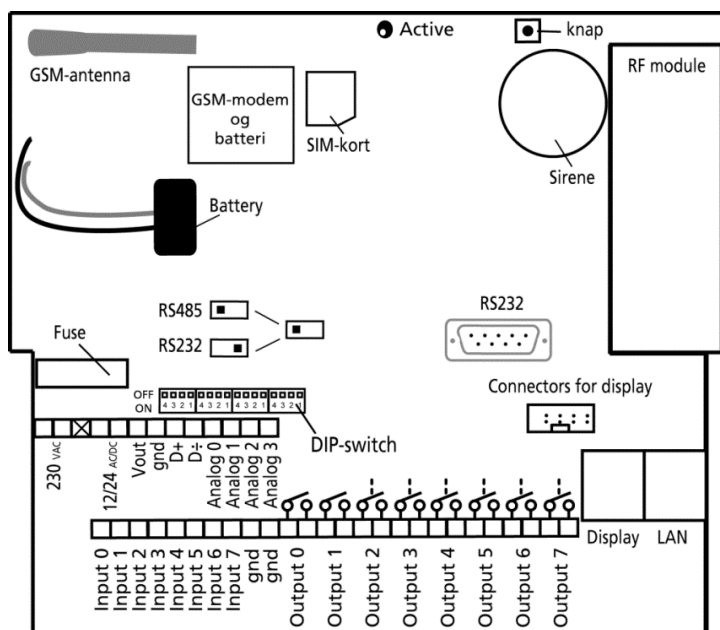

*) Note: No RF module

Connect all relay outputs and inputs to the unit. Use at least 0.25 Ø – or even stronger.

Mount digital outputs. Relay outputs are potential-free relay switch sets that are opened (NO) or closed (NC) by instructions to the unit. All relay outputs are opened before start-up.

Mount digital inputs. Digital inputs are activated by connection by either 0V (gnd) or on some models 24 VDC on the inputs (may be changed via ‘set-up’ in the enclosed PC program or by SMS/text message). When the connection is removed, the inputs are deactivated.

The unit is able to send an alarm both when the connection is turned on and when it is removed.

NB! At 24VDC, the high / low logic is exchanged for the text "Text when input is open" and "Text when input is closed"

NB! Input 0 may be used as connection/disconnection (toggle switch or bell switch).
Input 1 may be used as pulse counter or hour counter, 2 og 3as pulse counter.

Mount analog inputs. As default the analogue inputs function as ordinary digital inputs (all DIP - switches off).

If the inputs are to have an analogue function, the equipment and probes have to be connected between e.g. gnd and Ain1 or between gnd and Ain2. The figure below is an example of four analog inputs.

MOUNTING

Figure 2-2

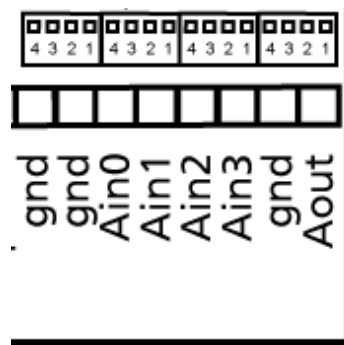

Each analog input has four DIP switches. Setting of inputs to standard equipment (0-10 VDC, 0/4-20 mA, PT100 probe or Profort probe), the DIP switches in the GSM module are to be adjusted as follows:

0-10 V DC:	DIP-switch no. 1 on (others off)
0/4-20 mA:	DIP-switch no. 2 on (others off)
PT100:	DIP-switch no. 3 on (others off)
Profort probe (PTC):	DIP-switch no. 4 on (others off)
Digital input:	All DIP-switches off

In case an alarm by power failure is wanted, a rechargeable battery must be mounted.

In case of poor GSM reception an external antenna may be mounted tilkables:

1. Remove the internal antenna
2. Fit the suitable screw connection with the bypass
3. Then mount an extra antenna*)

*) *If 12/24 AC supply with grounding is used, antennas and nuts must not touch or be fixed to electrically conductive building structures!*

Button:

Some of the models includes a button which has the following 4 functions:

1. Press down button and connect supply simultaneously. A “beep” will sound after 7 secs. The unit is now programmed to the default settings.
2. Press button in normal operation and a “beep” will sound after 7 secs. Let go of the button immediately, and macro 1 will be performed. If there is no function behind macro 1, nothing will happen.
3. If button is held down after 7 secs., another “beep” will sound after 14 secs. Hereby sabotage alarm is activated.
4. If button is pressed briefly in normal operation, then the unit will sound a series of “beeps”. It is now ready for the encoding of wireless detectors. If an alarm detector is triggered, the unit will reply by beeping fast and then stop beeping. The first detector is hereby activated. You can connect several detectors to the unit by repeating the process.

2.3 Installing a SIM card (not applicable for model Remote LAN)

If the unit contains a GSM modem, a SIM card needs to be installed. All common SIM cards may be used. 2G models cannot use 3G cards. Profort a/s recommends the use of a SIM card with subscription and not a pre-paid card as the latter often has an expiry date after e.g. six months.

Figur 2-3

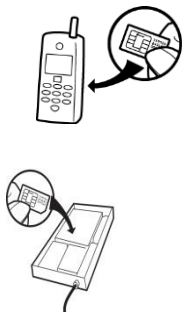

1. Choose a SIM card for the unit
2. Insert the SIM card in an ordinary cell phone
3. Make sure that the PIN number is 1234 or disable it
4. Check if you can call and send a text message to and from the SIM card in the phone
5. Remove the SIM card from the phone and install it in the GSM unit. See Figure 2-1 how to insert the card– don't forget to turn the metal down towards the print

2.4 Connect GSM unit

1. Check that inputs and relay outputs have been connected correctly
2. Replace the front of the unit
3. Connect the unit to its power supply. Wait approx. 10 secs. Mewhile the GSM modem connects to the GSM network. If the device has a sound source, four 'beeps' are heard, and the red diode starts blinking. After app. 20 sec., the unit is ready
4. If necessary, send a text message with "1234 OK" to return the GSM signal strength. It should preferably be above 25 %. If not, an extra antenna can be mounted
5. If using data to connect (GPRS) the signal strength should be above 35 %. If not, an extra antenna can be mounted

2.5 Connect LAN unit

1. Connect the unit to the internet: The unit is connected to the computer network with a normal LAN cable. When the unit can access the internet, it automatically connects to the Profort server
2. Connect to power supply: Mount the power supply and switch on power for the LAN unit. The red control diode is lit for approx. 20 secs. After that, the control diode will flash with one single flash every other second. It confirms that the LAN unit is ready and functioning correctly
3. Register the unit on the Profort webportal: Register yourself as a user on our website www.profort.com. Your *username* is found on the label on the back of the unit. The username is e.g.: ID001234. You choose your own *password*. Type in your *email adress*. That way we can send your code in case you forget it. Press *Register*.

MOUNTING

4. How to register the unit:

The screenshot shows the 'masterView setup' interface. On the left, there is a sidebar with 'Units for control' containing a tree view with items like 'Min DIN9', 'my holiday home', 'remote sommerhus', and 'rf'. Below this are '+ Create new user' and '+ Create existing' buttons, and a 'Manuals' section. The main content area is titled 'Choose your model' and contains a 'Control unit' form. The form has the following fields: 'GSM number' (ID123456), 'Pass' (1234), 'Description' (LAN), and 'Unit type' (multiGuard Remote LAN /). Below these is a section for APN settings with a note: 'Only used if APN is different from "Internet"'. The APN section has fields for 'Telephone company' (Not on the list), 'APN' (internet), 'APN user', 'APN password', and 'Username on the internet' (ID123456). There are 'APN' and 'Save' buttons at the bottom.

1. Go to setup.masterview.dk
 2. Choose: Create existing
 3. Enter the GSM number of the unit, e.g. ID123456 (see the back of the unit)
 4. Enter description
 5. Enter username, e.g. 123456 (same as GSM number, only without 'ID')
 6. Press 'Save'
5. Activate IR codes: The unit is now registered and the IR codes for the heat pump need to be activated. Type in the command: `mi(space)(producer name)`. It is important that you remember to put in a space between `mi` and the name of the unit. If your heat pump is from, e.g. Panasonic, you write "Panasonic" in *producer name*. The unit answers "OK" if everything functions as it should. If the unit answers "???", the heat pump is unknown and the functions need to be encoded manually. (See quick manual, enclosed in the box.)
6. Place the LAN unit correctly: The heat pump receives infrared signals from the LAN unit in the exact same way as a television receives signals from its remote control. Therefore it is important that the LAN unit is placed so that the heat pump can 'see' the IR codes of the LAN unit.
- a) Place the LAN unit in visible distance and max 6 metres from the heat pump. Make sure that there is access to both power supply and a computer network for the unit to be connected.
 - b) One of the two IR diodes needs to point towards the heat pump.
 - c) Test the position by checking whether the heat pump reacts when it is activated from the app. As extra equipment you can purchase an IR gooseneck or an IR cable in order to have more options for placing the LAN unit in visibility of the IR receiver.
 - d) When you are sure that your LAN unit is able to communicate with the heat pump, mount it to wall or ceiling.

Preparing the pc

3 PREPARING THE PC

If you want to use the Profort PC program set-up, perform the following steps:

Turn on the pc.

Connect a serial RS232 cable in the computer's COM port or via a USB adaptor. Use a nine-pin (male/female) serial cable or use a USB to RS232 serial converter.

If you use a USB cable, the driver of the cable shall be installed according to the guidelines.

Then connect the cable to the unit RS232 port.

Figure 3-1

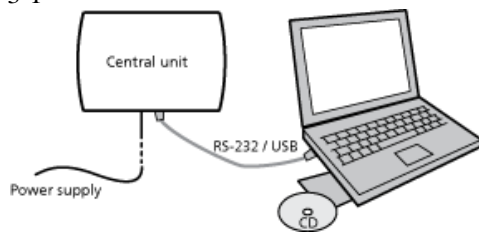

Download the PC program from the Profort homepage and type in product key. Below is shown the connections required in an RS232 cable.

Figure 3-2

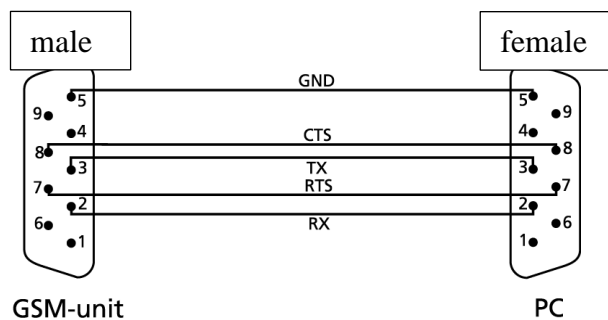

3.1 Minimum requirements for the PC

- Windows
- Screen resolution 1024x768
- COM-port or USB-port

3.2 Finding COM no.

A PC may have several COM ports, and the assignment of COM No. depends on which COM port is used for the set-up. You therefore have to check which COM No. Windows has assigned to the chosen COM port.

Preparing the pc

Find the number of the chosen COM port (here Windows 10 is used as an example).

1. Select the Start menu on your PC
2. Select Control Panel/System/About/Manage Devices
3. Select Ports (COM & LPT) > Communications port or USB-to-Serial Com Port
4. Read the number of the COM port. Figure 3-3 shows that the COM-port is 'COM1' when using the communications port and 'COM3', when using the USB port.

Figure 3-3

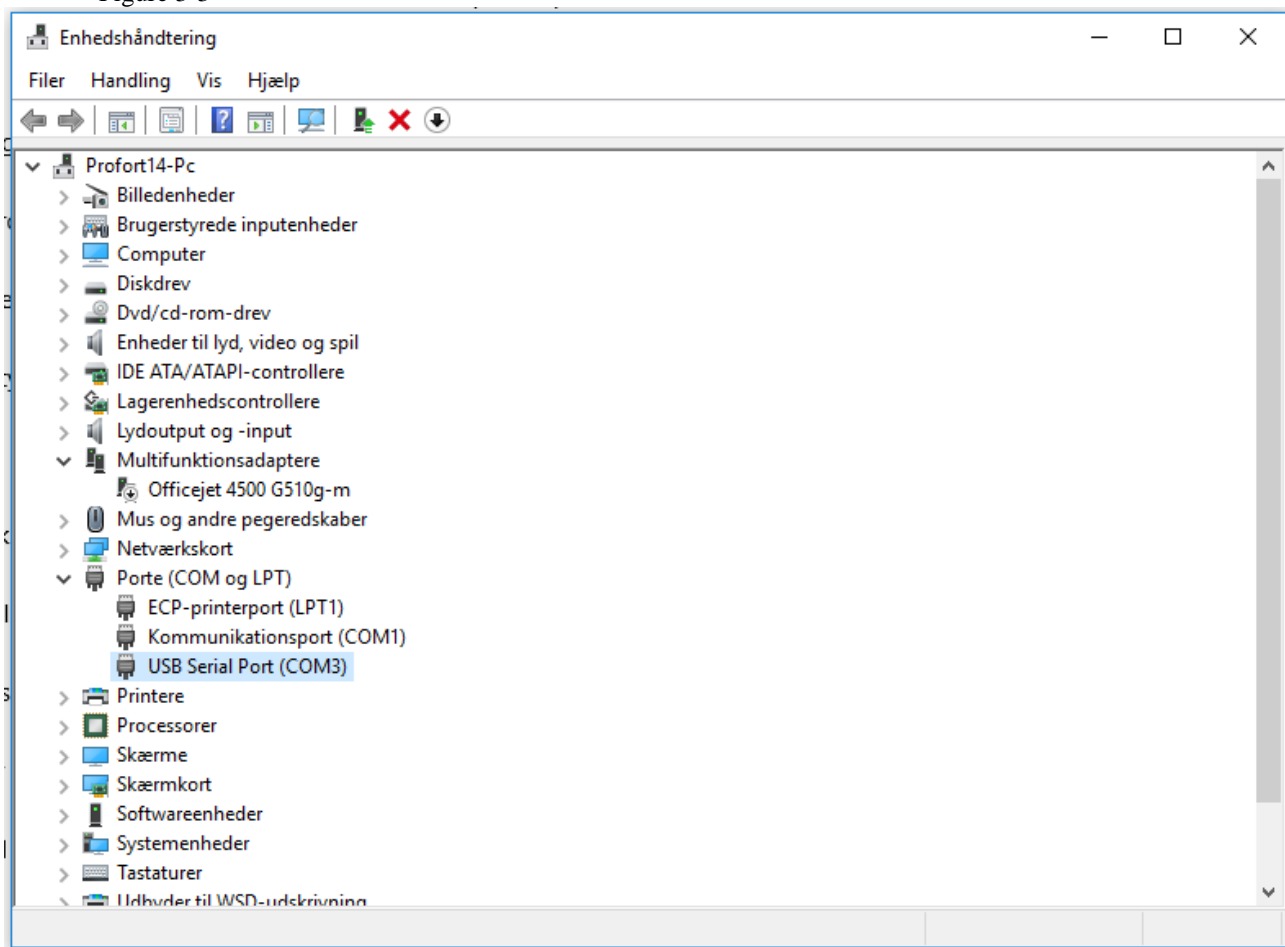

Notice that the next time you mount a cable in the same or another COM port, the assigned COM no. may have changed.

If you use a USB cable, you have to use the same slot in the computer each time.

Installation of the Profort pc program

4 INSTALLATION OF THE PROFORT PC PROGRAM

When the COM number has been identified start the PC program to set-up the unit.

Installation of Profort PC Program on the computer:

1. Download PC program from www.profort.com
2. Install the program according to the instructions on the screen.
3. Type in the product key in the box 'Product key' (the box opens automatically).
Use the product key M30GU8.
4. The program is now ready, and you can now set up units for use.

5 SET-UP ON PC

The description of set-up on PC is based on the extended set-up.

Each tab is named with a capital letter: An 'M' symbolizes tab Modem, 'T' indicates tab Inputs, 'O' stands for the tab Outputs, C stands for the tab Calendar, 'W' represents the Wireless tab, and 'V' marks the tab Various.

Headings (highlighted in bold) of each tab are also numbered with a digit, e.g. the area for the information of the device is numbered with M1 under the heading 'Central unit', and 'Setup' = M3 as in the figure below. The points in an area can similarly be referenced by using a lowercase letter.

Example 5-1

The function 'Send message to receivers on connect/disconnect' has the reference M3-a. It can therefore be found on the tab Modem (M) under 'Setup' (3) as the first point (a). As another example the timer is numbered C3. It is thus on the tab 'Calendar' in the area of number three.

Figure 5-1

Tab Modem (M)

Central unit

Present Password	GSM number	New Password	ID	Send
1234	12345678	1234	DEMO	<input type="checkbox"/>

Receivers

	Telephone no.	SMS	Voice	DTMF	Email	Approve	Sia ip	Zone	Send
1	23456789	<input checked="" type="radio"/>	<input type="radio"/>	<input type="radio"/>	<input type="radio"/>	<input type="radio"/>	<input type="radio"/>	<input type="checkbox"/>	<input type="checkbox"/>
2	1	<input type="radio"/>	<input checked="" type="radio"/>	<input type="radio"/>	<input type="radio"/>	<input type="radio"/>	<input type="radio"/>	<input type="checkbox"/>	<input type="checkbox"/>
3		<input checked="" type="radio"/>	<input type="radio"/>	<input type="radio"/>	<input type="radio"/>	<input type="radio"/>	<input type="radio"/>	<input type="checkbox"/>	<input type="checkbox"/>
4		<input checked="" type="radio"/>	<input type="radio"/>	<input type="radio"/>	<input type="radio"/>	<input type="radio"/>	<input type="radio"/>	<input type="checkbox"/>	<input type="checkbox"/>
5		<input checked="" type="radio"/>	<input type="radio"/>	<input type="radio"/>	<input type="radio"/>	<input type="radio"/>	<input type="radio"/>	<input type="checkbox"/>	<input type="checkbox"/>
6		<input checked="" type="radio"/>	<input type="radio"/>	<input type="radio"/>	<input type="radio"/>	<input type="radio"/>	<input type="radio"/>	<input type="checkbox"/>	<input type="checkbox"/>
7		<input checked="" type="radio"/>	<input type="radio"/>	<input type="radio"/>	<input type="radio"/>	<input type="radio"/>	<input type="radio"/>	<input type="checkbox"/>	<input type="checkbox"/>
8		<input checked="" type="radio"/>	<input type="radio"/>	<input type="radio"/>	<input type="radio"/>	<input type="radio"/>	<input type="radio"/>	<input type="checkbox"/>	<input type="checkbox"/>
9		<input checked="" type="radio"/>	<input type="radio"/>	<input type="radio"/>	<input type="radio"/>	<input type="radio"/>	<input type="radio"/>	<input type="checkbox"/>	<input type="checkbox"/>

Setup

Send message to receivers on connect/disconnect	<input type="checkbox"/>	Send
Number of seconds before voice message/DTMF tones are sent	2	<input type="checkbox"/>
Order of receivers		<input type="checkbox"/>
Send alarm to the user who latest contacted the unit	None	<input type="checkbox"/>

5.1 Start set-up

Make sure that the device is either connected to the RS 232 port or the USB connector on your pc, or that it is set up for the Internet (see chapter 9 for help with internet set-up).

Set-up on pc

Open the Profort pc program.

The first time you use the program, you must begin by filling in the settings of the application as described in Chapter 5.2. Continue to define the unit as described in Chapter 5.4- 5.10.

The setting is transferred to and stored in the GSM unit memory and is saved if the unit is turned off.

5.2 Settings

'Options' applies to all entities that are created in the Profort PC application. If you previously have created units in the program or converted the data from a previous version; you only need to fill in the settings if there are any changes. All changes will take effect on all devices created in the program.

Find 'Options' in the Setup by choosing: Project > Options at the top bar in the left corner of the window. A window as shown in Figure 5-2 opens.

Figure 5-2

Options

Com.port: 1

Connection via the internet:

Username on the internet:

Pin code PC modem:

State com.port:

Language: English

Schedule daily backup

Time:

To folder:

Ok

Figure 5-3

Quick Setup

Welcome to the Quick Setup version 5.01.26.

The Setup program is used for setup of the central unit through a serial cable. When the program is started, it tries to establish a connection to the central unit. At the bottom of the window the status line shows if the connection is established. If there is no connection check the communication port entered, check if serial cable is mounted correctly and the unit is started. If you want to change the com. port setting click the button <Back> and the window to setup the port is shown.

When setting up a unit a number of parameters are entered. The password of the unit is entered in the field "Present password". The first time setting up the unit 1234 is used. Remember that the pincode on the simcard should be 1234 the first time. In the field GSM number the number on the simcard in the unit is entered. If entered a new password of four digits and an ID number of 1 to 32 characters is used. The password is used when sending commands to the unit and the ID is used when the unit transmits alarms. If no ID is entered the unit transmits the password instead.

When the fields are entered, click the <Next> button.

Central unit

Present Password	GSM number	New Password	ID
1234	12345678	1234	DEMO

Cancel Next

5.3 Fill in the settings

Pin code: If the computer is to operate through a GSM modem, you need to enter the PIN code of the Modem SIM card. Otherwise the field is kept empty.

Modem/serial com.port: Enter the number of the COM port to which the unit is connected. Only free COM ports are shown. – If using the Internet to transfer your set-up, it is not necessary to specify the COM port (remember that the GSM device must then be set up to the Internet with text messages (see chapter 11)).

Set-up on pc

Connection via the internet: If you want the opportunity to control the unit online, the 'Connection via the Internet' must be checked. In the drop-down menu you must choose which web domain to use.

Furthermore, the unit must be activated and the wanted access to the internet set up. See how in the section about GPRS in chapter 5.10, if you use the PC Program, or in Chapter 5, Internet if you use text messages.

Username on the Internet: Enter a user name if you wish to have access to the Internet. This may consist of letters and numbers and can contain up to 16 characters. Symbols, special characters and spaces are not allowed.

The user name is to be used when you log onto www.profort.dk

State com.port: This feature is only activated in the Professional Profort PC Program

Language: Select language

Schedule daily backup: This feature is only active in the Professional Profort PC Program

Finish by pressing 'Ok'.

In the lower left side of the display is shown whether the connection to the unit has been successful. (Not applicable if using GSM modem.)

NB! If 'No connection' is shown; a wrong COM port has been shown, the unit has been turned off, or the RS232 cable has a defect.

If the text 'Connection to multiGuard' is not shown, you need to check whether the correct COM port has been selected.

5.4 Main page

The unit is to be defined on the main page in the square in the upper left-hand corner (Figure 5-4) . You may create several units in the Profort PC Program in case you have to handle more units at the same time.

Here a unit named "Demo" is created:

Set-up on pc

Figure 5-4

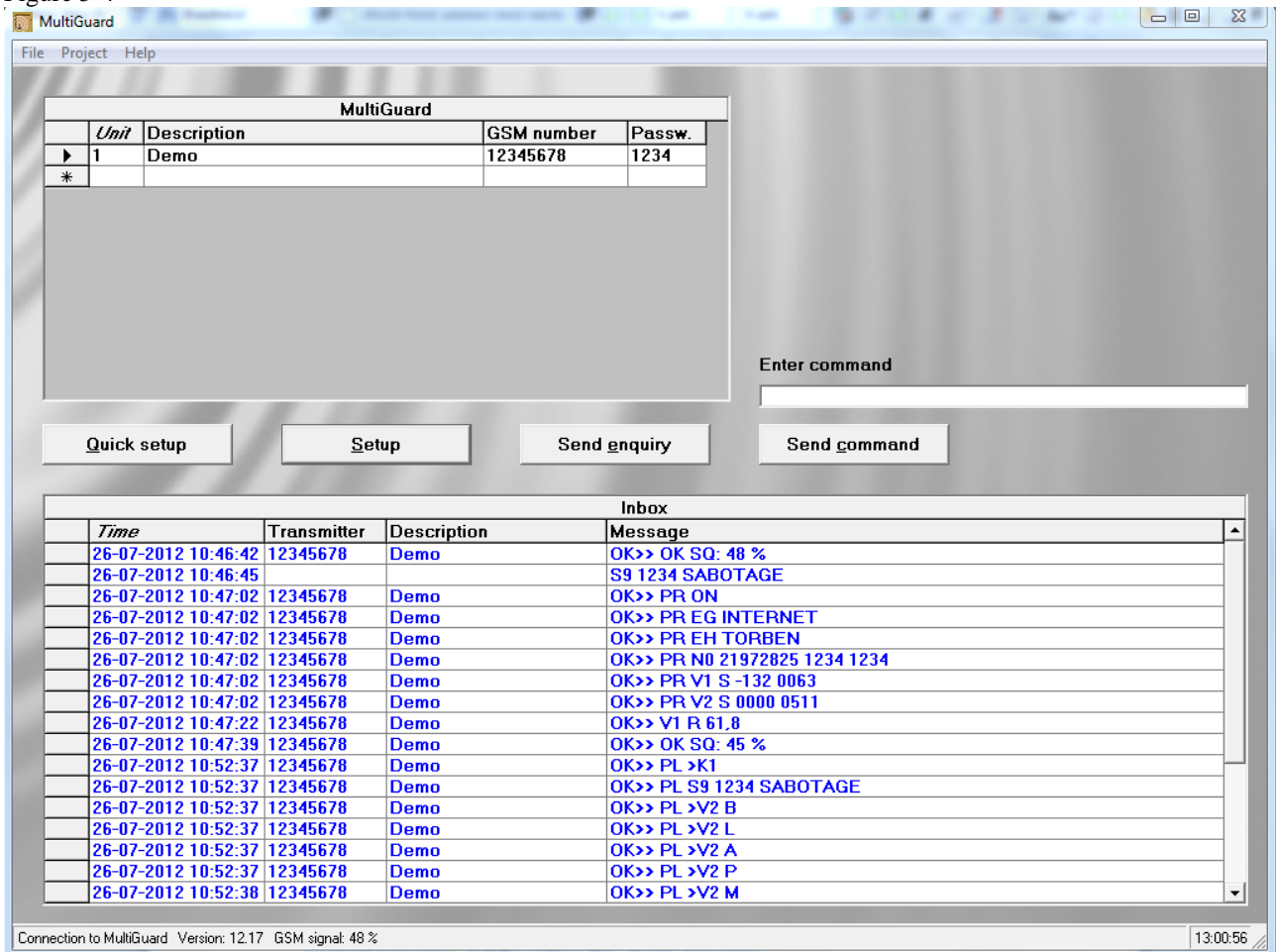

Create the unit on the main page:

1. Enter an optional number for the device.
2. Attach a description of the unit (max. 50 characters). The text is shown in the inbox (list of received messages) and the outbox (list of sent messages).
3. Enter the GSM No. of the unit (if any). The GSM No. is the same as the telephone number of the SIM card.
4. Mark the unit by clicking in the field to the left of the unit no. An arrow is shown in the field and the line is highlighted. The set-up is only valid for the unit indicated.

The further set-up of the highlighted unit takes place in six steps: Modem (chapter 5.5), Input (chapter 5.6), Output (chapter 5.7), Calendar (chapter 5.7), Wireless (chapter 0) and More (chapter 5.10).

Press 'Setup' in the center of the main page and continue in the new window.

Set-up on pc

The tabs in setup is organized the following way:

M = Tab Modem

I = Tab Input

O = Tab Output

C = Tab Calendar

W = Tab Wireless

M = Tab More

1-9 = The area on the tab with underlined heading

a-d = Points in an area

5.5 Tab: Modem (M)

Only fill in the Modem tab if the unit has been mounted with a GSM modem (if necessary see specifications in Chapter 1.1).

Tab Modem (M)

Modem | Inputs | Outputs | Calendar | Wireless | More

Central unit

Present Password: 1234 GSM number: 12345678 New Password: ID: Send:

Receivers

	Telephone no.	SMS	Voice	DTMF	Email	Approve	Sia ip	Zone	Send
1		<input checked="" type="radio"/>	<input type="radio"/>	<input type="radio"/>	<input type="radio"/>	<input type="radio"/>	<input type="radio"/>	<input type="checkbox"/>	<input type="checkbox"/>
2		<input checked="" type="radio"/>	<input type="radio"/>	<input type="radio"/>	<input type="radio"/>	<input type="radio"/>	<input type="radio"/>	<input type="checkbox"/>	<input type="checkbox"/>
3		<input checked="" type="radio"/>	<input type="radio"/>	<input type="radio"/>	<input type="radio"/>	<input type="radio"/>	<input type="radio"/>	<input type="checkbox"/>	<input type="checkbox"/>
4		<input checked="" type="radio"/>	<input type="radio"/>	<input type="radio"/>	<input type="radio"/>	<input type="radio"/>	<input type="radio"/>	<input type="checkbox"/>	<input type="checkbox"/>
5		<input checked="" type="radio"/>	<input type="radio"/>	<input type="radio"/>	<input type="radio"/>	<input type="radio"/>	<input type="radio"/>	<input type="checkbox"/>	<input type="checkbox"/>
6		<input checked="" type="radio"/>	<input type="radio"/>	<input type="radio"/>	<input type="radio"/>	<input type="radio"/>	<input type="radio"/>	<input type="checkbox"/>	<input type="checkbox"/>
7		<input checked="" type="radio"/>	<input type="radio"/>	<input type="radio"/>	<input type="radio"/>	<input type="radio"/>	<input type="radio"/>	<input type="checkbox"/>	<input type="checkbox"/>
8		<input checked="" type="radio"/>	<input type="radio"/>	<input type="radio"/>	<input type="radio"/>	<input type="radio"/>	<input type="radio"/>	<input type="checkbox"/>	<input type="checkbox"/>
9		<input checked="" type="radio"/>	<input type="radio"/>	<input type="radio"/>	<input type="radio"/>	<input type="radio"/>	<input type="radio"/>	<input type="checkbox"/>	<input type="checkbox"/>

Setup

Send message to receivers on connect/disconnect: Send:

Number of seconds before voice message/DTMF tones are sent: 2 Send:

Order of receivers: Send:

Send alarm to the user who latest contacted the unit: None Send:

5.5.1 Centralenhed (M1)

Create the identification information of the unit.

Nuværende password: Ved opstart er enhedens password 1234 som standard.

The PIN code of the SIM card must always be 1234 or deactivated in the telephone the first time the unit is installed or a new SIM card is mounted.

If password is lost, do the following:

- Remove the power from the unit, including back-up battery, if applicable
- Insert the SIM card in a mobile phone and change the PIN code to 1234. (If a PIN code has been activated in the mobile phone, a PUK code may be necessary).
- Mount the SIM card in the unit and connect the power.

The unit may now be coded by text message with password: 1234.

GSM Number: The SIM card telephone number is indicated here. It is optional, but a necessity if the watch function is to be used (e.g. in connection with logging of climate data).

New password: Enter a new four digit password. Should only contain digits - not letters. The SIM card PIN code will then also be changed if the PIN code is active.

You can also choose to deactivate the password so that it can no longer be used: Deactivate the SIM card PIN code in your mobile phone and insert it in the unit again. You can consult the mobile phone manual for help with deactivation.

ID: Here a possible ID is entered for the unit, consisting of digits or letters (max. 32 characters). The ID will accompany all alarms.

If the unit is to send alarms with SIA-IP, the ID number of the central control shall be used as ID (if needed, see types of alarms below).

NB! The password is used to be able to send commands to the unit. The ID follows the alarm from the unit. If this field is not filled in, the ID will be the same as the password.

5.5.2 Receivers (M2)

Telephone number: A total of 25 telephone numbers may be stored in the unit. They may receive alarms and/or be approved to operate in the system exclusively.

A telephone number can be a max. of 15 digits. Country code is not necessary. If you wish to use it, you shall enter '+country code', not '00country code'.

Types of alarms: Alarms may be received either as 'SMS', 'Voice', 'DTMF', email or 'SIA-IP'.

Set-up on pc

If 'Voice' is chosen, you must record a message for the alarm (see chapter 13). (Only applicable for models with voice message).

With DTMF, the modem calls a control centre, for example, and plays a tone sequence.

If the unit is a GSM unit and if you wish to receive the alarm as an email, then indicate the number which your telephone operator uses for emails, e.g. 200=TDC or TDC affiliates (this works in Denmark). If you use another phone service provider, see chapter 6.7.1 By marking the email option a new field for the address will appear. The email address must not exceed 48 characters

If the unit has a LAN interface, alarms can only be sent as emails. When *email* is pressed, 999 will appear in place of the phone number. Indicate then the preferred email address in the email space.

If you want the alarm dispatched as a SIA IP protocol for a control centre, this must be indicated at receiver 1. The IP number and port number of the Centre must be indicated in the telephone number field. The two numbers must be separated by a colon. Do not use spaces, and full stops in the IP number are to be maintained.

In order for the control centre to recognize the unit, you receive an ID number to be defined as the ID of the GSM unit (ID, see page. 31).

It is a prerequisite that an agreement has been made with the control centre, who will also give information on the relevant numbers.

Note that only Zones can be transferred via SIA-IP

If several types of alarms are wanted, for example both text messages and voice message, it is necessary to create the same number twice.

The receiver may acknowledge alarms with voice message or DTMF tones with #. If a receiver acknowledges, the alarm sequence stops and the following receivers on the list are not disturbed. Without acknowledgement, the alarm sequence continues to the end of the list of receivers.

Approve: Indicates which numbers are allowed to change the set-up or for example operate relays. If one or more telephone numbers are marked in the field 'Approve', the unit will only accept SMS and calls from these numbers.

Only one choice of either 'approve' or 'type of alarm' per line can be approved.

If thereafter the approval shall be revoked, this takes place by deleting the receiver in question.

If no numbers are created with approval, everybody may contact the unit.

NB! In case of a faulty approved telephone number, this has to be corrected in the set-up. It will be necessary to connect a PC with a cable to contact the unit.

Zone: 'Zone' can be used for dividing the alarms in "areas" with specific receivers. An input (see chapter 5.6 Tab: In) in a specific zone will only place an alarm with receivers in the same zone. If 'Zone' is omitted, all alarms are sent to all receivers.

Set-up on pc

Only one zone may be indicated. If the same telephone number is to be called in case of alarm from, for example, two zones, the actual telephone number shall be created twice.

If 'Zone' is blank, alarms are received from all zones. System alarms are attached to zone 0 by default.

Send: In case of changes in the set-up, the program automatically marks 'Send'. Thus, information on updating of the unit is sent, when the set-up is finished by pressing the button 'Send/Save'.

5.5.3 Setup (M3)

Send message to receiver when connect/disconnect (M3-a): Message is sent to receivers in zone blank when the unit is disconnected and connected. Optional.

Number of seconds before voice message/DTMF tones are sent: Number of seconds that the unit must wait before it sends a voice message or DTMF tones. This delay secures that the alarm is not delivered in a possible answering service. Optional. (Only some units have voice message)

Select possible order of receivers: Receivers are numbered 1-9 and from 10 and up with the letters A-P. The order in the receiver list may be changed, for example 342A. The unit will first send the message to receiver 3, then 4, 2 and 10 (A).

The message will only be sent to the receivers that have been listed in this field.

Send alarm to the user who has contacted the unit last (M3-d): If the option is selected, the alarms are sent from the beginning of the receiver list as well as to the person who has had the latest contact with the unit.

Choose whether the latest user shall receive the alarms as text message, as voice message, or both as text and voice message.

The function makes it possible for more people to operate the unit and get the relevant messages without being created as receivers. At the same time the users avoid getting alarms when they are not using the unit. In a workplace it might be different people who activates a unit, and thus only one person might benefit from receiving alarms.

Set-up on pc

5.6 Tab: Inputs (I)

The table in chapter 1.1 shows the number of inputs on your device.

Tab Inputs (I)

I1 ←

Digital inputs	
Text when input is opened	Zone
0 TEMPERATURE LOW	<input type="checkbox"/>
1	<input type="checkbox"/>
2	<input type="checkbox"/>
3	<input type="checkbox"/>
4	<input type="checkbox"/>
5	<input type="checkbox"/>
6	<input type="checkbox"/>
7	<input type="checkbox"/>

I2 ←

Analog inputs													
Type	Scale min	Low text	Zone	Point 1	Medium text	Zone	Point 2	High text	Zone	Scale max	I/D in %	Filter	Send
1	30	TEMPERATURE LOW	<input type="checkbox"/>	0	TEMPERATURE OK	<input type="checkbox"/>	30		<input type="checkbox"/>	60		<input type="checkbox"/>	<input type="checkbox"/>
2			<input type="checkbox"/>			<input type="checkbox"/>			<input type="checkbox"/>			<input type="checkbox"/>	<input type="checkbox"/>
3			<input type="checkbox"/>			<input type="checkbox"/>			<input type="checkbox"/>			<input type="checkbox"/>	<input checked="" type="checkbox"/>
0			<input type="checkbox"/>			<input type="checkbox"/>			<input type="checkbox"/>			<input type="checkbox"/>	<input checked="" type="checkbox"/>

I3 ←

Setup	
Input 0 used for connecting/disconnecting	<input type="checkbox"/> Send
Input 1 used for counting	<input type="checkbox"/> Send
Input 2 used for counting pulses	<input type="checkbox"/> Send
Input 3 used for counting pulses	<input type="checkbox"/> Send
Filter time	10 sec. <input type="checkbox"/>
Only send the alarm if text is entered	<input type="checkbox"/> Send
Only send alarm every 15 minutes	<input type="checkbox"/>
Send different voice messages on open and close	<input type="checkbox"/>
Activate digital inputs	GND <input type="checkbox"/>

Digital inputs (I1)

Text when input...: Instead of default texts, you may create user-defined texts that are shown on change of state on inputs. The text may be defined for opened and for closed state. (max. 64 characters). The SMS will be sent in case of alarm (when the state of an input is changed).

If you only want an alarm at 'opened' or 'closed', text is only entered in the field for the wanted function. Furthermore, either 'Text' or 'ID + Text' shall be selected in 'Only send alarm if text has been created' under 'Setup' at the bottom of the tab.

If the unit has not been coded with user-defined texts, standard messages are sent with alarm:

- Sx: Close input x (e.g. x = 0-7 if the device has eight digital inputs, x = zero, if the device has one digital input)
- Bx: Open at input x

Zone: 'Zone' is optional and may be used to organise alarms in up to eight areas. Alarms in zone 1 are for example only sent to receivers in zone 1. (Remember also to indicate the zone in the call list, see Chapter 5.5 Tab: Modem).

If a zone with no corresponding receiver is indicated, no alarm will be sent. Is used where an input only has to control a relay, e.g. a siren.

The relay outputs follow the zone, i.e. the eight inputs may be put in certain zones that each operates the corresponding relay output.

Set-up on pc

The zone organisation takes place by indicating a digit in the zone field. When working with zones, the central unit reacts by distributing all relay inputs on outputs.

NB! The central unit distributes all inputs in zones, i.e. relay 0 is zone 0, relay 1 is zone 1, etc. This means that you cannot move the relays around (see e.g. p. 41).

Filter: If 'Filter' has been selected, the alarm will only be sent where the change of state has been stable during the filter time. Superfluous states lasting only an insignificant number of sec. are discarded and will not produce an alarm.

Is used e.g. when a float in a pump well is settling down so that only one alarm is sent.

'Filter' cannot be used together with 'Wait'.

Vent: Ønsker du, at enheden afventer et halvt min., før en alarm udløses, skal 'Vent' vinges af. Et evt. personale kan så f.eks. nå ud af et alarmområde efter tilkobling.

Analogue inputs (I2)

The unit can read analogue values on the analogue inputs (e.g. Ain1). The outputs can be controlled as a reaction on the reading. They can be attached to technical equipment for measuring of an exact value, e.g. temperature.

Type: Measurement equipment is chosen (0-10 V, 0/4-20 mA, PT 100, Profort 007995). Models with built-in temperature sensor are pre-programmed from the factory.

If the type field is not completed, the analogue inputs work as digital.

Scale min.: For 0-10 V and 0/4-20 mA you define yourself the desired values for Volt and
+
Milliampere (from -999 to +999). Decimal places are not allowed.

Scale max

The values for the other measuring equipment are indicated with fixed intervals that may, however, be changed.

Example

The values for 0 V and 10 V are to be defined. 'min.' corresponds to 0 V, and 'max.' to 10 V (default). You can e.g. define that -20°C corresponds to 0 V and 60°C to 10 V.

Point 1: Define Point 1 and/or Point 2 as limits for allowed values. If the limit values are
+
passed, an alarm is sent.

Point 2

Set e.g. Point 1 to 0°C and Point 2 to 30°C. If the temperature rises to above or falls below 0°C or above or below 30°C, an alarm is released with either Low, Medium or High text (see below).

Low, Medium and High text:

Low text is sent when e.g. the temperature falls below the value defined in Point 1. Cf. the example above when the temperature falls below freezing.

Medium text is the alarm when the temperature rises above the value in Point 1, e.g. above 0°C, or it falls below the value in Point 2, e.g. below 30°C.

High text indicates that the value has risen above the indication in Point 2, e.g. that the temperature is above 30°C.

The text in the fields can max. be of 64 characters.

If, in the meantime, you wish to be informed of a measurement, e.g. a temperature in a room, you send a request to the unit via SMS text with the command `V1 R` to ask for input 1, `V2 R` to ask for input 2, etc..

S/F in %: Indicates a maximum allowed deviation at measurement. Alarms at deviation of the interval. The allowed deviation is indicated in percentage by the scale. It needs to be at least 0,5 %. Note a number between 0,5 and 9,9. A positive number alarms at increase while a negative one alarms at decrease in the measurement. X=0,5,...-9,9.

Setup (I3)

Input 0 is used for connecting/disconnecting: Select how to change the state of an input. Either 'Level' (level control) where closed is disconnected or 'Pulse' (pulse control). When blank, input 0 functions as normal input.

Input 1 is used as counting: If you wish to use input 1 as counter you shall mark whether to count pulses or minutes. In the field at input 1, a limit value may be defined, e.g. 500 in closed text. The unit then automatically sends an SMS and resets when the limit value has been reached.

When blank, input 1 functions as a normal input.

Filter time: Indicates variable filter time for ports. Under 'Digital inputs' (see previous) is marked which inputs that need the given filter time. Choose from 10 sec. up to 64 hours. Inputs 2 and 3 can be used as pulse counter if the boxes are ticked.

Only send the alarm if text is entered: If text has been created on inputs (opened and/or closed) and wireless detectors, an alarm is sent (wireless detectors only with models Technic RF and Master RF). In case of blank text fields, alarm is discarded.

In case of 'ID + Text', state, ID and text is sent. In case of 'Text' only text is sent. The alarm text may be adapted to interface to pager systems or CCTV via the serial port.

Only send alarm every 15 minutes: Mark the field if you only want to receive one alarm of the same kind each 15 minutes.

Set-up on pc

If input 1 for example alternates between closed and open, the unit will send an alarm when the input closes and one when it opens. The unit will then first send an alarm again after 15 minutes if input 1 closes or opens.

The function applies to alarms of the same kind. This means that e.g. an alarm, when input 2 is opened, starts its own time interval of 15 minutes.

This function is valuable when e.g. a PIR sensor is mounted to the device.

Activate digital inputs: The inputs shall be set as either GND or 24 VDC mode. In GND mode, the input is activated by connection to 0 VDC (GND), and the closed state is achieved. If the connection is removed, an open state is reached. In 24 VDC mode, the input is activated by connection to 24 VDC, and the closed state is achieved. If the connection is removed, an open state is reached.

5.6.1 Commands in the text field

It is possible to enter one or more commands in the text field for digital and analog inputs. By this, both a text message can be sent and a command executed when the state of the input is changed.

- Commands in the front of the text field carries out the command, also when the unit is disconnected. If commands are put last in the text field, the command will not be carried out in disconnected state.
- In case of more commands, these are separated by semicolons.
- Commands start with '<' and end with '>'.

Example of a command in a text field

Enter e.g. the command `<S1;S2;S3>` in order to close relays 1, 2 and 3.

Example 5-2

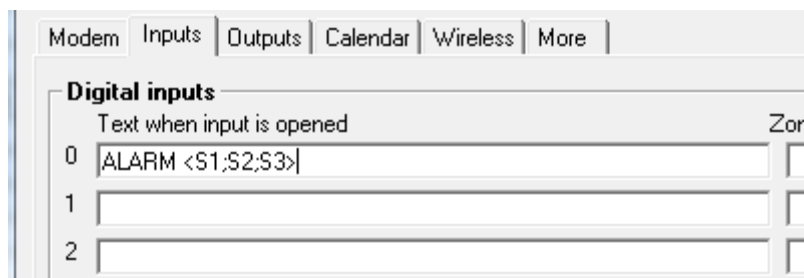

	Text when input is opened	Zor
0	ALARM <S1;S2;S3>	
1		
2		

In Example 5-2 the unit will send an alarm with the phrase "ALARM" when input 0 is opened. The command '<S1;S2;S3>' in the end of the text field furthermore causes the unit to close output one, two and three, and that an alarm is sent only when the unit is connected.

Example of a duty roster

The file inputs may also be used to control a duty roster. In the receiver file the call list itself is first created for the duty roster (cf. Chapter 5.5 Tab: Modem):

Set-up on pc

Example 5-3

Receivers					
	Telephone no.	SMS	Voice	DTMF	Email
1	+4511111111	<input checked="" type="radio"/>	<input type="radio"/>	<input type="radio"/>	<input type="radio"/>
2	+4511111111	<input type="radio"/>	<input checked="" type="radio"/>	<input type="radio"/>	<input type="radio"/>
3	+4522222222	<input checked="" type="radio"/>	<input type="radio"/>	<input type="radio"/>	<input type="radio"/>
4	+4522222222	<input type="radio"/>	<input checked="" type="radio"/>	<input type="radio"/>	<input type="radio"/>
5	+4533333333	<input checked="" type="radio"/>	<input type="radio"/>	<input type="radio"/>	<input type="radio"/>
6	+4533333333	<input type="radio"/>	<input checked="" type="radio"/>	<input type="radio"/>	<input type="radio"/>

If a person is to receive both an SMS text and a voice message, the same telephone number is created twice in the call list, e.g. so Peter has position 1+2 (+4511111111), Jens position 3+4 (+4522222222) and Hans position 5+6 (+4533333333).

The order of the call list means that the alarm is sent to Peter, first as SMS and then as voice message. Then to Jens as SMS followed by a voice message, and finally to Hans as SMS and voice message.

Day 1, Peter and Hans are on duty. Day 2, Jens and Hans are on duty. Day 3, only Peter is on duty. The following is written in the tab inputs:

Example 5-4

Digital inputs		
	Text when input is opened	Text when input is closed
0		PETER HANS <NR 1256>
1		JENS HANS <3456>
2		PETER <12>

When input 0 closes, alarms will hereafter only be sent to receiver 1+2 and 5+6 (Peter and Hans). By closing input 1, alarm will be sent to receiver 3+4 and 5+6 (Jens and Hans). By closing input 2, alarm is sent to receiver 1+2 (Peter).

The last closed input is valid. If e.g. first input 1 and then input 2 are closed, alarm is then sent to no. 1+2 until a closure takes place at another input.

Example of a zone connection

To connect a single zone following command is sent to the device:

Example 5-5

Digitale indgange	
	Tekst når indgang brydes
0	<ON Z1>
1	

In When input 0 closes, alarms will hereafter only be sent to receiver 1+2 and 5+6 (Peter and Hans). By closing input 1, alarm will be sent to receiver 3+4 and 5+6 (Jens and Hans). By closing input 2, alarm is sent to receiver 1+2 (Peter).

Set-up on pc

The last closed input is valid. If e.g. first input 1 and then input 2 are closed, alarm is then sent to no. 1+2 until a closure takes place at another input.

Example of a zone connection

To connect a single zone following command is sent to the device:
Example 5-5 zone 1 is connected when input 0 is opened.

In order to connect more zones at one time, the relevant zones are entered, separated by semicolon:

Example 5-6

Digital inputs	
	Text when input is opened
0	<ON Z1;ON Z2;ON Z3>
1	

In Example 5-6 the zones 1 to 3 are connected when input 0 is opened. It is necessary to repeat 'ON' before each zone. A total of seven zones (Z0-Z7) may be connected.

5.7 Tab: Outputs (O)

The table in Chapter 1.1 (Specifications) shows the number and types of output of your device.

Output relays may be controlled or activated manually or at change of state on the inputs.

The outputs are as default deactivated. They may be automatically activated in several ways (the example shows a device with four outputs):

1. From 10 sec. to 15 min. or constantly. Output 0-3 follow zone 0-3.
2. Output follows input. Output 0-3 follow input 0-3 including Ain0-Ain3, but only for inputs where texts have been created. NB: This set-up rules out 'show connection/disconnection'.
3. Output shows connection/disconnection. Output 0-3 show connection and disconnection in zone 0-3.
4. Combined alarm and connection/disconnection. Output 0-1 follow zone 0-1. Output 2-3 show connection and disconnection in zone 0-1.
5. Command in the text box on an entry, for example `TEXT <S3>` closes output 3 on alarm

Tab Outputs (O)

	Relay outputs			Setup
	Opened	Closed	Send	
O1	<input checked="" type="radio"/>	<input type="radio"/>	<input type="checkbox"/>	Activate relay output on alarms <input type="checkbox"/>
O3	<input checked="" type="radio"/>	<input type="radio"/>	<input type="checkbox"/>	Relay outputs reflect connected/disconnected state <input type="checkbox"/>
	<input checked="" type="radio"/>	<input type="radio"/>	<input type="checkbox"/>	Pulse time <input type="text" value="10 sec."/> <input type="checkbox"/>
	<input checked="" type="radio"/>	<input type="radio"/>	<input type="checkbox"/>	
O2	<input checked="" type="radio"/>	<input type="radio"/>	<input type="checkbox"/>	Analog output
	<input checked="" type="radio"/>	<input type="radio"/>	<input type="checkbox"/>	Set voltage (0.0 - 10.0) <input type="text"/> <input type="checkbox"/>
	<input checked="" type="radio"/>	<input type="radio"/>	<input type="checkbox"/>	
	<input checked="" type="radio"/>	<input type="radio"/>	<input type="checkbox"/>	

Set-up on pc

Relay outputs (O1)

Opened: Indicates normal state of relays. If outputs are to close by activation of alarm, 'Opened' is marked. Outputs will then be opened at start-up.

Closed: Indicates normal state of relays. If outputs are to open by activation of alarm, 'Closed' is marked. Outputs will then be closed at start-up.

Analogue output (O2): Enter a value for the voltage at the output (0-10 V). (Only model DIN6 has an analogue output).

Setup (O3)

Activate relay output on alarms: Indicates whether output shall activate by alarm and for how long. 10 sec., 20 sec., 40 sec., 1 min., 2 min., 4 min. 8 min., 15 min., infinite, reflects inputs. 'Reflects inputs' means that the outputs reflect the corresponding inputs if a text has been created. A blank field indicates that the outputs do not activate.

If the alarm comes from an input or wireless detector in zone 0, output 0 is activated; zone 1 activates output 1, etc.

Figure 5-5 shows how the outputs follow the inputs when the device contains multiple outputs. In case of text for both analog and digital inputs, the analog inputs will have priority to draw outputs one and two.

Figure 5-5

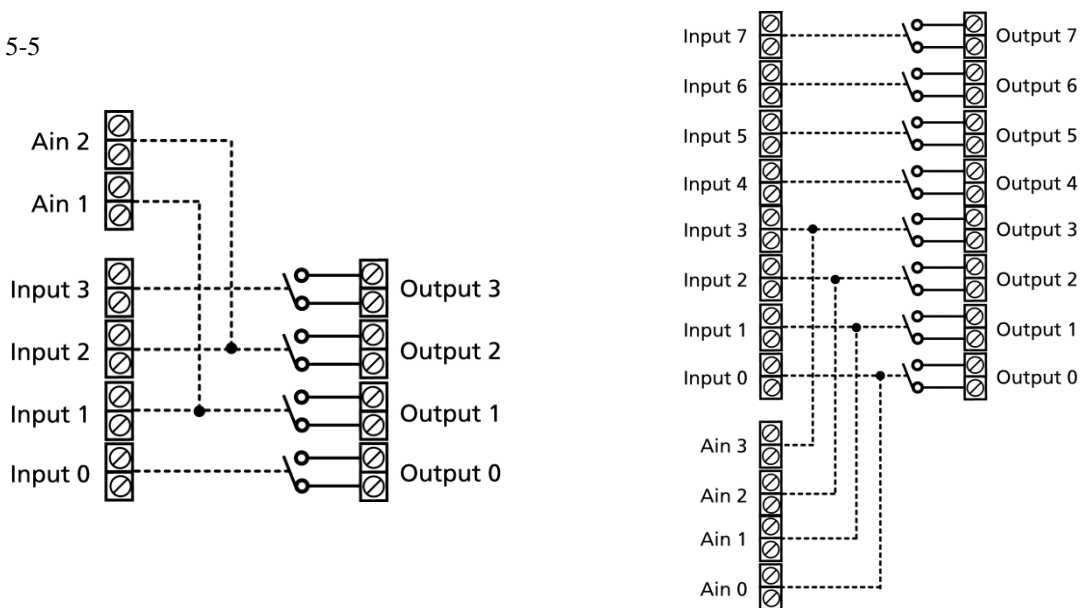

Relay outputs reflect connected/disconnected: If so marked, the outputs are closed when the unit is connected and open when the unit is disconnected. If this field has not been completed, the relay works as normal.

If the outputs are to be closed in disconnected state, 'Closed' is to be marked in the box 'Outputs'.

NB! If the outputs are defined to display both alarms and disconnected/connected state the distribution is done by this: outputs 0-3 are meant for alarms from zones 0-3, and outputs 4-7 are meant for showing disconnection/connection of zone 0-3. See examples in

Set-up on pc

Figure 5-6

Figure 5-6

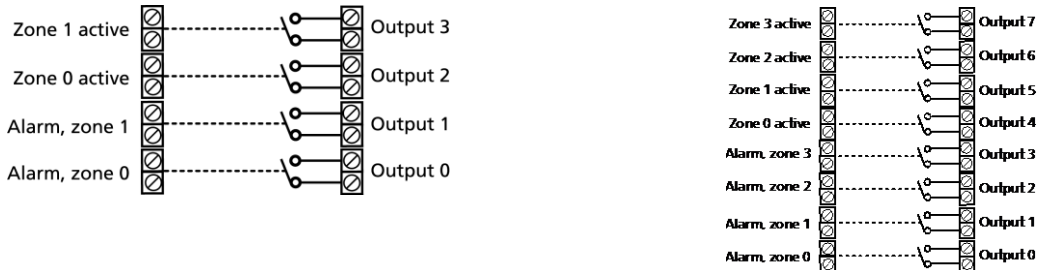

5.8 Tab: Calendar (C)

Tab Calendar (C)

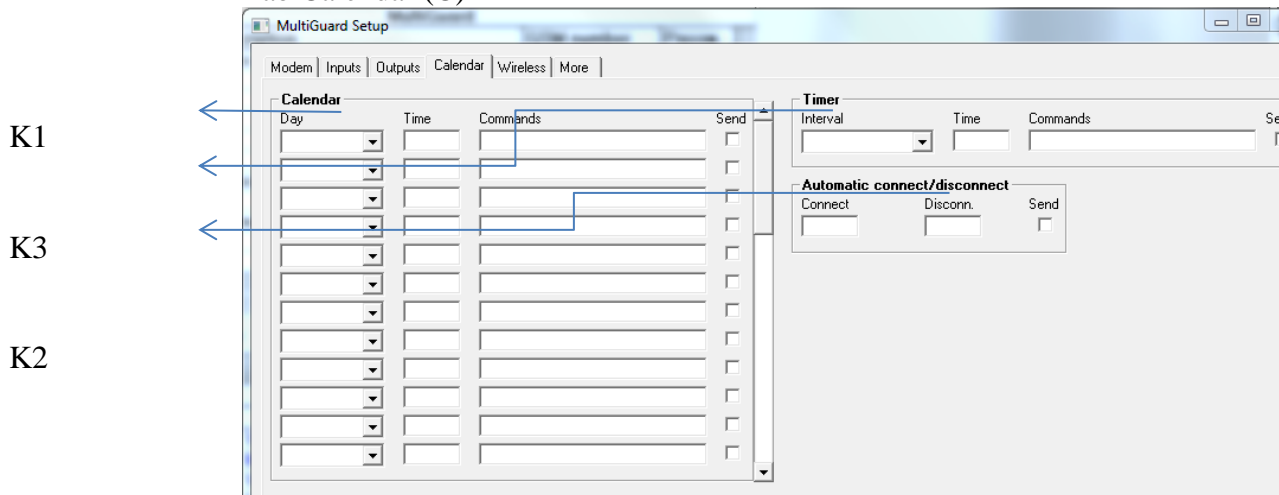

Calendar (C1)

It is possible to create 36 activities. A connection and a disconnection count as two activities. If you replace an old activity with a new one, the program will delete the old activity before it creates the new.

- Day Indicate time for execution of command:
 - Daily: all weekdays
 - Monday, Tuesday, Wednesday, Thursday, Friday, Saturday, Sunday: specific weekday
 - Date: specific date, select from calendar window or type in date, e.g. June 23, 2018 = '230612'
 - 'blank': activity deleted
 - Time Hour for execution of command, e.g. 9.30 pm = 0930
 - Command Command for execution on the chosen hour, e.g. 'ON', 'OFF', 'S0', 'S1'
- When a calendar function for a specific day is performed, it will be automatically deleted.

Set-up on pc

Automatic connect/disconnect (C2): Fill in a time for automatic disconnection and connection of the unit. If only automatic connection is wanted, 'Disconnect' is not filled in. To be indicated with HHMM (HH = hours / MM = minutes, e.g. 2015).

Timer (C3)

Interval: Choose between 'Weekly', 'daily', 'No. of 15 minutes' and 'No. of minutes' for how often the timer shall activate. Or mark the blank field to deactivate.

As default, the timer is programmed to continue till you stop it. This may take place by selecting the blank field as interval or by means of the command Tx (x = 0-9). T + zero stops the timer while 1-9 indicates the no. of times that the timer shall activate, e.g. it starts twice at T2. Use the command TU if the timer shall again run indefinitely (until deactivation).

The command may be sent from the field 'Send command' on the main page, via text on an input, with an SMS text or in-built macro.

Time: Indicates the time of activation of the timer. At 'Weekly' (always Wednesday) and 'Daily' is stated the time with HHMM. At 'No. of 15 minutes' is indicated the number of 15 minutes between activations, e.g. 0004 for each hour. 'Minutes' is stated with no. of minutes between activation, e.g. 0010 for each 10 minutes.

Commands: Enter possible commands for the unit to carry out when the timer activates.

If you enter e.g. MA D1;MA A1 the unit will send a status update for digital input 1 (MA D1) as well as a status update for analog input 1 (MA A1), when the timer activates.

If the command field is empty when the timer is connected, the unit will send status messages on the state of the inputs.

Status messages report from the analog and digital inputs that are text defined. May show closed or opened state, an analog value or number of pulses. The unit will also send a status message on connection of the unit.

If a status message is sent from an input with a command in the text field, the unit will also carry out the command in question.

5.9 Tab: Wireless (W)

Only applies to units with wireless interface.

On the tab Wireless, the set-up concerns the wireless detectors. This goes for i.e. the wanted texts and a series of other functions. If the detector is a temperature or humidity meter, further specification is filled in by pressing the button 'Analogue', see Figure 5-7.

Set-up on pc

Tab Wireless (W)

The screenshot shows the 'Wireless' configuration window. It contains a table with columns for 'Detector no.', 'Text when detector is activated', 'Zone', 'Lev.', 'Wait', 'Analog', and 'Send'. Below the table are sections for 'Setup' (including 'Only send the alarm if text is entered', 'Detector supervision', 'Battery low warning', 'Only send wireless alarm every 15 minutes', and 'Sound on alarm from wireless detector'), 'Connect/Disconnect' (including 'Connect', 'Disconnect', and 'Connect. After 8 min. status (changed/active)'), and 'Display' (including 'User password'). Blue arrows labeled W1, W2, W3, and W4 point to the 'Detector no.' field, the 'Text' dropdown, the 'Connect' checkbox, and the 'User password' field respectively.

Wireless (W1)

Detector No.: The six-digit serial number of the detector.

Text when detector is activated: Text to be transferred by alarm and shown in the log. (NB: Compulsory when logging data). This may be e.g. name or title of the object. The text can be max. 64 characters.

Zone: It can be indicated which zone (0-7) the detector shall belong to. Remember in this case to indicate the zone in the receiver list (Chapter 5.5 Tab: Modem).

Personal alarm: A personal alarm may via attachment to a zone activate an output. If you e.g. create a personal alarm in zone 2, output 2 will be activated by assistance-pressure, while output 3 starts an attack pressure cf. Table below.

Figure 5-7

The 'Analog' configuration window shows two rows of settings. The first row is for 'climaSpot: Temperature' with 'Alarm' action and 'TEMP ALARM' text. The second row is for 'climaSpot: Humidity' with 'Only log' action and 'HUMMIDITY ALARM' text. An 'Ok' button is at the bottom.

Set-up on pc

Table 1

Personal alarm belonging to	Assistance (brief push)	Attack (long push)	Activates output
Zone 0	*	*	0
Zone 1	*	*	1
Zone 2	*	*	2 3
Zone 3	*	*	3
Zone 4	*	*	4 5
Zone 5	*	*	5
Zone 6	*	*	6 7
Zone 7	*	*	7

Lev.: Here, the sensitivity of a seismic detector is adjusted. The interval goes from zero, which is not activated, to five or blank, which is the highest sensitivity. Default is five.

Wait: When marking the field, the unit will wait for 30 seconds before an alarm is forwarded. This makes it possible to disconnect the unit before the alarm is released. When connecting, it similarly takes half a minute before the alarm can be released.

Analog: When you press the button, a new window opens for set-up: (see Figure 5.7)

Type: Vælg sensortype
 Handling: Vælg Alarm/Kun log
 Ok: Vælg normalinterval
 Alarm tekst: Tekst ved alarm
 Ok tekst: Tekst ved normaltilstand

NB: If you wish to log data, the unit telephone number or ID number shall be defined so that the unit can get the time from the network, see page 30.

Setup (W2)

Send kun alarm hvis tekst er oprettet:

Blank: Alarm is sent from all available detectors with detector number.

Text: Alarm consisting of text is only sent from detectors with text attached.

ID + text: Alarm containing text, ID and detector number is only sent from detectors with text attached.

The alarm text may be adapted to interface to pager systems or CCTV via the serial port.

Detector supervision: Detectors send an ok signal with short intervals to the unit. Thus possible faulty detectors are discovered. In case of blank, detectors are not monitored.

Battery low warning: If you mark this field, the unit will receive a warning when the battery in the detector should be replaced. The alarm is shown in the display and saved in the log, but is not sent as text or voice message.

If this field is not marked, the battery is not monitored.

Only send wireless alarm...: If you use GSM, you may indicate whether wireless detectors shall send alarms each or each 15 minutes. If the field is blank, the unit will send an alarm each minute, if the field has been marked, this will take place each 15 minutes.

If you do not use GSM/LAN, the unit will receive an alarm each 6 seconds. This time interval cannot be changed.

Lydsignal Sound on alarm from wireless detector: The unit will give a sound signal at alarm. There is no sound signal with blank.

Connect/Disconnect (W3)

Connect: Select, if required, connection on zone (0-7). If zone is not filled in, the connection is valid for all zones.

Remember, if required, to activate 'Send message to receivers on disconnection/connection' in tab 'Modem'.

Disconnect: Select, if required, zone (0-7). If zone is not filled in, the disconnection is valid for all areas.

Remember also to activate 'Send message to receivers on disconnection/connection' in tab 'Modem'.

Connect after 8 minutes status (changes): When connecting, the unit sends a status of the detectors after 8 minutes. The unit compares the number 'now' with the number at the time when the unit was last disconnected. The purpose is to secure that the unit registers 'the same' detectors after having been disconnected. (Only applies to units which contain features for wireless detectors).

Set-up on pc

Connect after 8 minutes status (active): When connecting, the unit sends a status of the detectors after 8 minutes. Shows which detectors are active. The purpose is to see which detectors, the unit may see, and which have possibly become defective during the disconnection period. (Only applies to units which contain features for wireless detectors).

Display (W4)

Enter a separate user password, if required. The user password (four digits) is used to log on from the display. (It only works on devices with display).

If 1234 is selected as user password, you only have to press OK on the display to log in. If another password than 1234 is selected, this password always shall be entered before pressing OK.

The user password allows limited access to the system. With a user password it is only possible to operate a part of the unit display menu while the password of the unit gives full access. Thereby the unit is protected against unauthorised use.

5.9.1 Command execution in text field

It is also possible to enter one or more commands in the text field for detectors. When activating the detector in question, an alarm will be sent, while the command is carried out. As for commands in the text field for inputs:

- Commands in the front of the text field carries out the command, also when the unit is disconnected. If commands are put last in the text field, the command will not be carried out when disconnecting.
- In case of more commands, these are separated by semicolons.
- Commands start with '<' and end with '>'. E.g.: <S1 ; S2 ; S3> to close relays 1, 2 and 3.

Figure 5-7

Detector no	Text when detector is activated
012345	MONA LISA <N1 20101010>

The command N1 replaces receiver no. 1 with the telephone number defined in the text field; here 20101010.

Set-up on pc

5.10 Tab: More(V)

Tab More (V)

Modem | Inputs | Outputs | Calendar | Wireless | More

Setup

Return command Send

Send also alarm via cable/Internet Send

Send also sabotage alarm when unit is disconnected

Automatic connect after disconnect (number of minutes)

Send power alarm Immediately

Activate siren on alarms

Create watch in unit

Standard texts (are installed)

Text	Zone	Send
Power failure	Power failure	<input type="checkbox"/>
Power ok	Power OK	<input type="checkbox"/>
Sabotage	SABOTAGE	<input type="checkbox"/>
Text in the display	NO ALARM	<input type="checkbox"/>

GPRS

Phone service provider: GPRS is not used

APN:

APN user:

APN password:

Send:

Username on the internet: THOMAS

Macros

Macro name	Commands	IR	Send
0 STATUS	V3 R,V0 R	<input type="checkbox"/>	<input type="checkbox"/>
1 HEAT10	I1	<input type="checkbox"/>	<input type="checkbox"/>
2 HEAT16	I2	<input type="checkbox"/>	<input type="checkbox"/>
3 HEAT17	I3	<input type="checkbox"/>	<input type="checkbox"/>
4 HEAT18	I4	<input type="checkbox"/>	<input type="checkbox"/>

Retrieve infrared codes from archive

Setup (V1)

Return command: If marked, an acknowledgement for a sent command is sent to the sender.
If the field is not marked, there is no acknowledgement.

The unit acknowledges with *OK>> + sent command* when it knows the commands, and *??>> + sent command* when the unit does not recognize the sent command.

The acknowledgement is delivered to the sender.

Send also alarm via cable/Internet: If marked, an alarm is sent via cable or the Internet

Send also sabotage alarm when unit is disconnected: When so marked, a sabotage alarm is sent, also in case the unit is disconnected. If blank, the sabotage alarm is not sent in disconnected state.

Send power alarm: When marking 'Immediately' the text 'Power alarm' is sent right away when the external power supply fails. Hereafter the unit runs for 30 minutes where after it closes down. If the supply returns within 30 minutes the unit will send the default text 'Power Ok'

If '30 minutes' is marked, the unit will run for 30 minutes while monitoring whether the supply returns. If this does not happen, the unit sends a power alarm and closes down. When the supply returns, the standard text 'Power Ok' will be sent.

Power alarm requires the unit to be mounted with a rechargeable battery.

Models with li-ion battery do not close down, but continue until the battery is empty.

Set-up on pc

Activate siren on alarms: You can choose if and for how long the unit shall emit a sound signal on alarm. There is no sound signal with blank. Choose between 10 sec., 20 sec., 40 sec., 1 min., 2 min., 4 min., and 8 min. Models with built-in siren emit an extra loud siren.

Create clock in unit: The time in the PC will be transferred to the unit. A clock is used for time stamping the log, automatic connection/disconnection and sending of status messages. It is necessary to set the clock, if you wish to log data.

Indicate the unit GSM number/telephone number under Tab: Modem, if the unit shall automatically update the time once a week.

Set up new text for default texts (V2)

Text: Enter, if required, a new text instead of the different default texts.

Zone: Select, if required, a zone (0-7) if the text is to be sent from this specific zone to a specific telephone no.
Remember to indicate the zone in the call list (:Tab Inputs).

GPRS (V3)

Phone service provider: Indicate the Internet access of the unit. Either choose not to use the Internet ('GPRS not used') or activate access by marking the service provider of your SIM card. If your service provider is not on the list, choose: "Not listed."

Notice that the fields regarding the Internet under Files → Settings also have to be completed (see section on Fill In Settings under 5.2, p. 28).

APN, User and Password: APN is short for Access Point Name and indicates how the unit obtains connection to the Internet via your telephone operator.

Some telephone operators furthermore require user name and password to create the connection.

If you choose a service provider from the list, the program will fill in the fields automatically.

Contact your telephone operator to obtain APN, user name and password.

Macros (V4)

Macro name: A macro can collect one or more commands into one 'super command'. Here you enter a name of your choice of up to 16 characters, e.g. 'Start pump'. If the unit receives an SMS with this text, the instructions entered in the field 'Command' are carried out. It is thus not necessary to remember and enter the normal command.

You may create a total of 10 macros (M0-M9/R0-R9). They can be activated through the chosen name in a text message or by a call and DTMF tones. (Telephone call and DTMF are only able to activate Macro M0-M9.)

Macros are accepted without password.

Set-up on pc

Commands: Here you indicate the instruction/command or instructions/commands (max. 48 characters) to be attached to the macro name chosen. More commands are separated by semicolon. For example `P0 ; T1` to pulse relay 0 and activate the timer once.

If you have named a macro, but not inserted a command in the command field, the IR recording function will be activated when you press 'Save/Send'. Hereafter, the red LED light will flash quickly for 30 sec. or turn off when a valid IR code has been received.

IR: Units with built-in IR interface can record and play infrared signals from e.g. a remote control. In the field 'IR' there must be an infrared code from e.g. a remote control. See more about recording or downloading of IR codes in chapter 15.

Get infrared codes from archive: Have IR codes been downloaded or recorded and then archived, they can be found here. See more about archiving of IR codes in chapter 15.

Send infrared codes to archive: Send IR codes, recorded in the Profort PC Program, to the archive. Press the button and type in the manufacturer and unit of the object that fit the IR codes, e.g. LG heat pump.

The archive can be found at the top of the main page (Figure 5-4) under Files > Infrared codes.

Send/Save: After finishing the set-up, the information is saved on the PC by pressing the button 'Send/Save'. Setup transfers everything that is marked with 'Send' – the Profort PC Program automatically marks the 'Send' when there is made a change.

Or
Execute

Remember that the unit has to have a connection, either serial, via modem or over the Internet. In the bottom left corner of the window shall read: 'connection to <product name>'

During the transfer of the set-up, the unit 'beeps' three times if it has a sound source.

If the transfer is not successful, this message is shown: "Commands not sent". Please try again.

Set-up on masterview

6 SET-UP ON MASTERVIEW

6.1 Create user

Go to <http://setup.masterview.dk> and press 'Create profile':



Fill in the information and press 'Create': Don't forget to accept terms and conditions.

Create new user

User.	Company information
Name <input type="text"/>	Company name <input type="text"/>
Last name <input type="text"/>	Address <input type="text"/>
Email <input type="text"/>	Postal code <input type="text"/>
Direct number <input type="text"/>	City <input type="text"/>
	Company telephone number <input type="text"/>
	Company email <input type="text"/>
Login.	Website <input type="text"/>
Login name <input type="text" value="hco"/>	Industry <input type="text"/>
Password <input type="password" value="*****"/>	
<input type="checkbox"/> I accept terms and conditions	<input type="button" value="Create"/> <input type="button" value="Close"/>

Set-up on masterview

6.2 Log ind

Log in to the portal by filling in 'user name' og 'password'. You can always update your user profile by choosing 'Settings'.

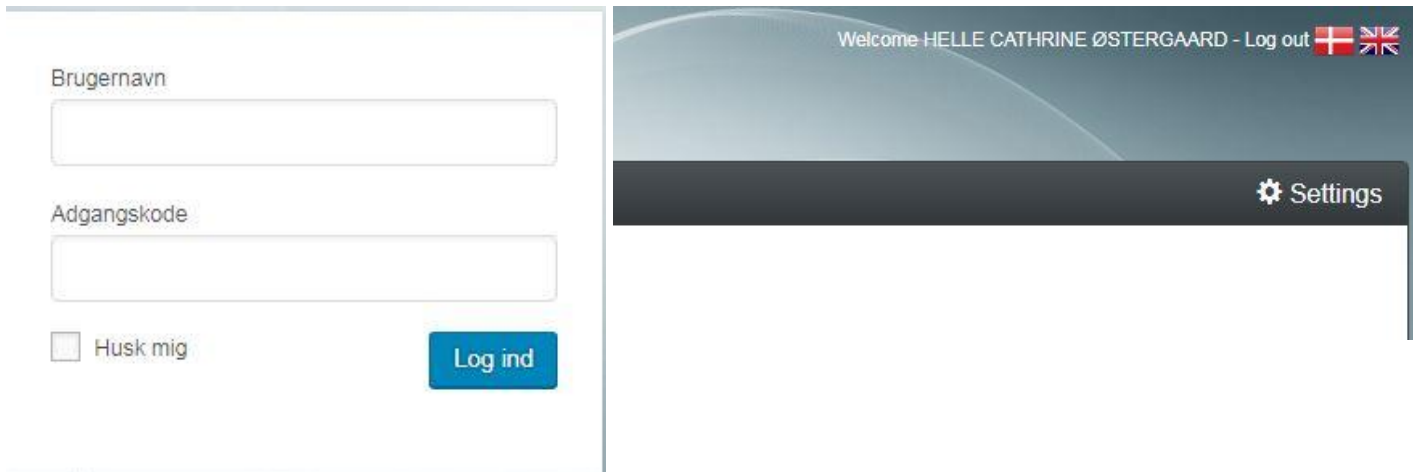

The image shows a login form on the left and a user profile header on the right. The login form has two input fields: 'Brugernavn' (Username) and 'Adgangskode' (Password). Below the password field is a checkbox labeled 'Husk mig' (Remember me) and a blue 'Log ind' button. The user profile header on the right shows 'Welcome HELLE CATHRINE ØSTERGAARD - Log out' with Danish and UK flags, and a 'Settings' button with a gear icon.

6.3 Create a unit

Choose 'Units for control' and 'Create new user':

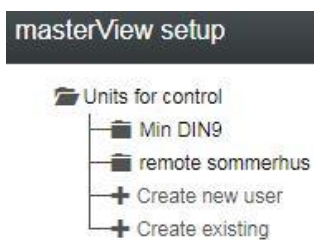

Choose your model from the selection on the right:

Choose your model



myHome Alarm



multiGuard Remote IO



multiGuard Remote LAN



multiGuard Technic IO



multiGuard Technic RF



multiGuard DIN4



multiGuard DIN6



multiGuard DIN9



multiGuard Master IO



multiGuard Master RF



Piccolo Server

Set-up on masterview

For this example, multiGuard DIN9 is chosen'.

Enter GSM number and description and press 'Save':



The screenshot shows a form titled "Control unit" with the following fields and values:

GSM number	Pass	Description	Unit type
<input type="text"/>	1234	<input type="text"/>	multiGuard DIN9 /

Buttons: "APN" (left), "Save" (right).

If your telephone subscription is using a different APN (data access to GPRS) than 'Internet' (e.g. TELIA) press 'APN' and choose telephone company. Contact your provider if you're not sure which APN they are using.

The unit is now created using telephone no. E.g. **12345678** as **user name**.

If you **already have a user name** and wish to combine several units under this user name, simply change 'User name on the internet' to the desired one.

If the unit is for **LAN** you need to read the ID on the back of the unit, e.g. 'ID001234'. Enter: '001234' in 'GSM number' and 'ID001234' in 'User name on the internet'.

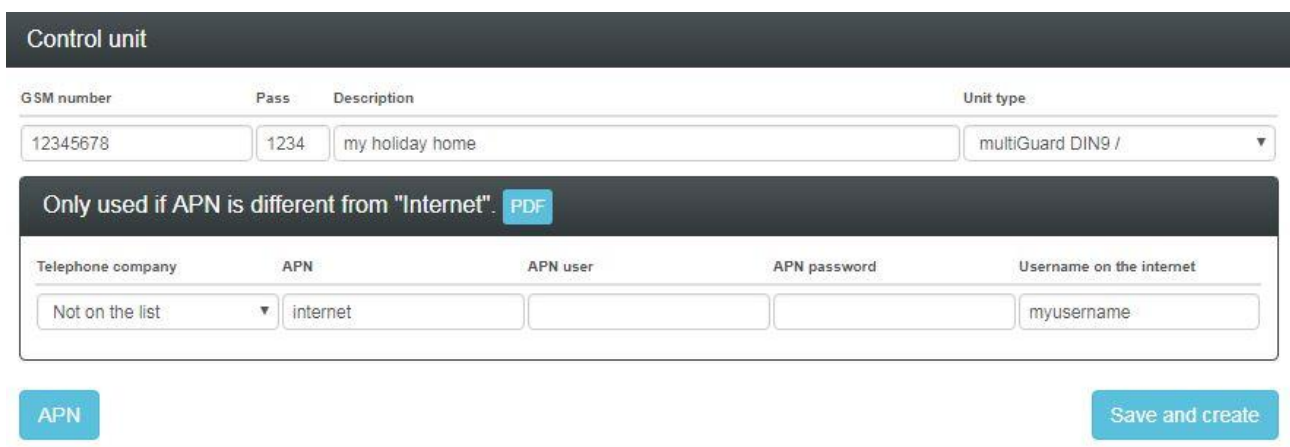

The screenshot shows the "Control unit" form with the following fields and values:

GSM number	Pass	Description	Unit type
12345678	1234	my holiday home	multiGuard DIN9 /

Section: "Only used if APN is different from 'Internet'" (with a PDF icon)

Telephone company	APN	APN user	APN password	Username on the internet
Not on the list	internet	<input type="text"/>	<input type="text"/>	myusername

Buttons: "APN" (left), "Save and create" (right).

Press 'Save and create' and confirm that you want to save:

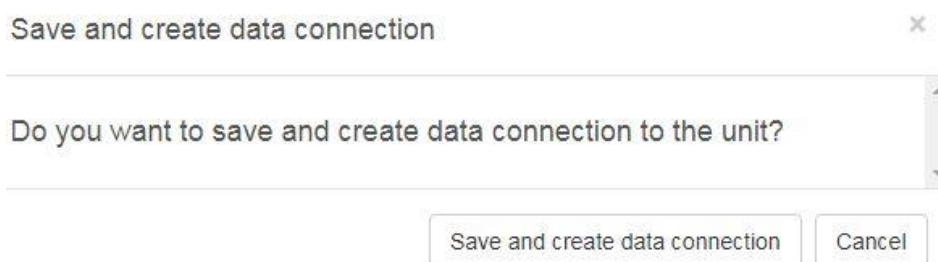

The screenshot shows a dialog box titled "Save and create data connection" with a close button (X) in the top right corner. The main text asks: "Do you want to save and create data connection to the unit?". At the bottom, there are two buttons: "Save and create data connection" and "Cancel".

Set-up on masterview

A text message is now sent to the unit to create data connection. The user name on the server becomes the GSM number, in this instance: '12345678'. All further communication with the unit is via data transmission (GPRS) via the Profort server.
Be aware that the SIM card from this point is using data.

6.4 Retrieve setup from the unit

If the unit has already been programmed and you just need to make some alterations, you can retrieve the setup the following way:

Click on the image of the unit, choose 'Retrieve from unit' and press 'Retrieve':



The setup is now transferred to the program on the server and can be viewed on the individual tabs.

6.5 Connect to existing device

Like chapter 6.3, except that there is no communication with the unit.

6.6 Retrieve a template

There are several templates in masterView e.g. for Irrigation and Slurry Tank surveillance. Click on the image of the unit, choose 'Retrieve template', choose template and press 'Retrieve'. Now, some default settings that we have selected will be downloaded to the program on the server. Note that the program has not yet been transferred to the GSM unit itself.

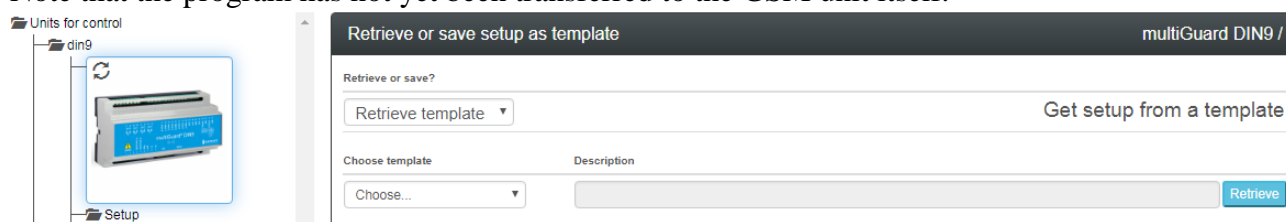

If you want the program transferred from server to unit, just press 'Mark everything':

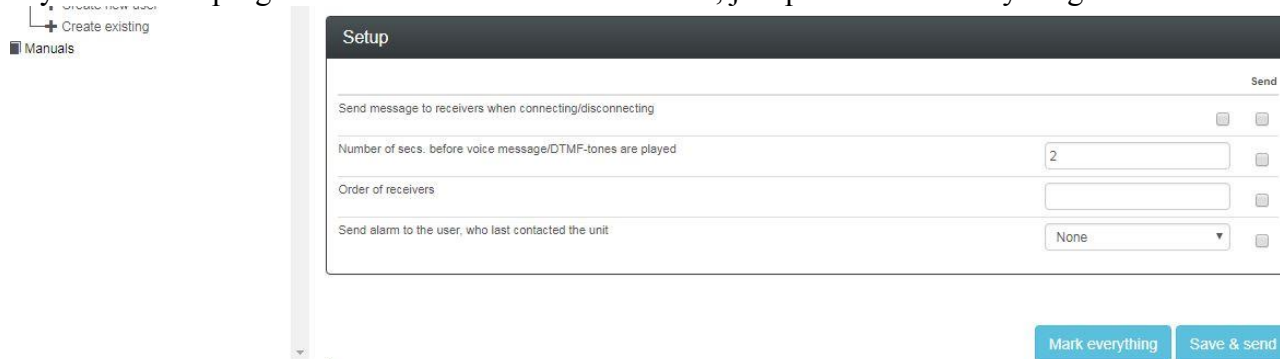

6.7 Change the setup

Setup is divided into 8 tabs: Receivers, Digital inputs, Analog inputs, Outputs, Calendar, Wireless, Macros and Other.

6.7.1 Receiver

Here you can set up the receivers of alarm from the device. Choose 'Receiver' in the sidebar to the left:

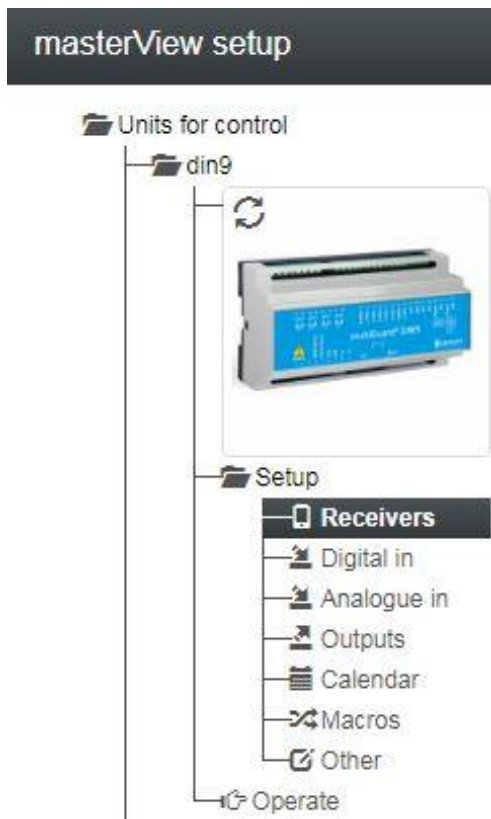

Create receivers of alarms such as text messages, voice messages, DTMF (tones), email.

For units with SW version through 14.26, E-mails can be configured by code 200 for TDC SIM cards.

For units with SW version from 14.27, e-mail are configurable at code 999. (Code 999 means that Profort's server is used for sending emails). Functionality assumes that the SIM card includes data and that multiGuard is set up for data.

'Approved numbers' means that only the listed numbers can contact the units or Sia-IP (internet alarm). Note that not all devices include voice messages!

Set-up on masterview

Zone (0..7) means that the receiver only receives alarms from certain zones:

Modtager										
	Telefonnummer	SMS	Tale	DTMF	Email	E-mail	Godkend	Sialp	Zone	Send
1	<input type="text" value="11111111"/>	<input checked="" type="radio"/>	<input type="radio"/>	<input type="radio"/>	<input type="radio"/>	<input type="text" value="E-mail"/>	<input type="radio"/>	<input type="radio"/>	<input type="text"/>	<input checked="" type="checkbox"/>
2	<input type="text" value="11111111"/>	<input type="radio"/>	<input checked="" type="radio"/>	<input type="radio"/>	<input type="radio"/>	<input type="text" value="E-mail"/>	<input type="radio"/>	<input type="radio"/>	<input type="text"/>	<input checked="" type="checkbox"/>
3	<input type="text" value="200"/>	<input type="radio"/>	<input type="radio"/>	<input type="radio"/>	<input checked="" type="radio"/>	<input type="text" value="min@email.dk"/>	<input type="radio"/>	<input type="radio"/>	<input type="text"/>	<input checked="" type="checkbox"/>
4	<input type="text" value="11111111"/>	<input type="radio"/>	<input type="radio"/>	<input type="radio"/>	<input type="radio"/>	<input type="text" value="E-mail"/>	<input checked="" type="radio"/>	<input type="radio"/>	<input type="text"/>	<input checked="" type="checkbox"/>
5	<input type="text"/>	<input checked="" type="radio"/>	<input type="radio"/>	<input type="radio"/>	<input type="radio"/>	<input type="text" value="E-mail"/>	<input type="radio"/>	<input type="radio"/>	<input type="text"/>	<input type="checkbox"/>
6	<input type="text"/>	<input checked="" type="radio"/>	<input type="radio"/>	<input type="radio"/>	<input type="radio"/>	<input type="text" value="E-mail"/>	<input type="radio"/>	<input type="radio"/>	<input type="text"/>	<input type="checkbox"/>

End with 'Save & Send'.

6.7.2 Digital inputs

Select 'Digital in' in the side panel on the left.

Fill in the texts for open and close for the relevant entries. Zone (0..7) means that certain alarms can be sent to specific receivers. If the zone is 'blank', all alarms are sent to all receivers who are not in a zone. 'Filter' means that the alarm must be constant for a certain time before it is transmitted (counteracts false alarms).

Digital inputs						
	Text when input is opened	Zone	Text when input is closed	Zone	Filter	Send
0	<input type="text"/>	<input type="text"/>	<input type="text"/>	<input type="text"/>	<input type="checkbox"/>	<input type="checkbox"/>
1	<input type="text"/>	<input type="text"/>	<input type="text"/>	<input type="text"/>	<input type="checkbox"/>	<input type="checkbox"/>
2	<input type="text"/>	<input type="text"/>	<input type="text"/>	<input type="text"/>	<input type="checkbox"/>	<input type="checkbox"/>

Filter time length should be specified at the bottom like other additional setup options for digital inputs.

Setup	
Input 0 is used for connection/disconnection	<input type="text"/> <input type="checkbox"/> Only send alarm if text has been created <input type="text"/> <input type="checkbox"/>
Input 1 is used as counter	<input type="text"/> <input type="checkbox"/> Only send alarm every 15 mins. <input type="checkbox"/>
Input 2 is used as pulse counter	<input type="checkbox"/> <input type="checkbox"/> Activation of digital inputs <input type="text" value="GND"/> <input type="checkbox"/>
Input 3 is used as counter	<input type="checkbox"/> <input type="checkbox"/>
Filter time	<input type="text" value="10 secs."/> <input type="checkbox"/>

End with 'Save & Send'.

Set-up on masterview

6.7.3 Analogue inputs

Select 'Analogue in' and enter alarm texts and alarm points:

Type = 0-10V, 0-20mA, PT100, Profort PTC or 4-20mA. (Remember to put DIP switches on device print).

The scale can be freely adjusted to suit the current conditions. Eg. pressure height can be changed from $\div 5 - 20$ to $\div 100 - 400$ cm.

Relevant text messages that fit the range are written into the fields.

Points 1 and 2 are two alarm points that distinguish the three intervals. If only one alarm point is used, point 2 is changed to the same as 'Scale max', and 'High text' is omitted.

Analogue inputs													
Type	Scale min.	Low text	Section Zone 1		Medium text	Section Zone 2		High text	Zone	Scale max.	I/D in %	Filter	Send
1	Profort PTC	-132	low temp	0	2	normal temp	0	30	high temp	0	63		<input checked="" type="checkbox"/>
2													<input type="checkbox"/>

6.7.4 Outputs

Select 'Outputs'. Relays are opened by default. If necessary, change relays to 'closed' in quiet mode. Set 'Activation of output on alarm' to the desired time. The zone determines which output is activated. Eg. alarm from zone 1 will activate relay1. If 'Outputs reflect disconnected/connected mode' is chosen, e.g. Input 1 controls the physical output 1.

6.7.5 Calendar

Select 'Calendar' and enable commands in up to 36 calendar functions (date, weekday and daily). Remember, only one function per given minute.

In 'Timer', you can get a status message daily or weekly (every Wednesday e.g. at 1200). The message will be the current text on the inputs.

In case of 'Automatic connection/disconnection', two times for automatic connection and disconnection can be encoded (e.g. connection at 17:00 and disconnection at 07:00).

Calendar			
Day	Time	Commands	Send
<input type="text"/>	<input type="text"/>	<input type="text"/>	<input type="checkbox"/>
<input type="text"/>	<input type="text"/>	<input type="text"/>	<input type="checkbox"/>
<input type="text"/>	<input type="text"/>	<input type="text"/>	<input type="checkbox"/>
<input type="text"/>	<input type="text"/>	<input type="text"/>	<input type="checkbox"/>
<input type="text"/>	<input type="text"/>	<input type="text"/>	<input type="checkbox"/>
<input type="text"/>	<input type="text"/>	<input type="text"/>	<input type="checkbox"/>

Timer			
Interval	Time	Commands	Send
<input type="text"/>	<input type="text"/>	<input type="text"/>	<input type="checkbox"/>

Automatic connection/disconnection		
Connection	Disconnection	Send
<input type="text"/>	<input type="text"/>	<input type="checkbox"/>

Set-up on masterview

6.7.6 Wireless

Note that the tab 'wireless' is only applicable for units with wireless module.

Detector no.	Text for detector	Zone	Level	Analog	Send
012345				<input checked="" type="checkbox"/>	<input type="checkbox"/>
012345				<input checked="" type="checkbox"/>	<input type="checkbox"/>
012345				<input checked="" type="checkbox"/>	<input type="checkbox"/>
012345				<input checked="" type="checkbox"/>	<input type="checkbox"/>
012345				<input checked="" type="checkbox"/>	<input type="checkbox"/>
012345				<input checked="" type="checkbox"/>	<input type="checkbox"/>
012345				<input checked="" type="checkbox"/>	<input type="checkbox"/>
012345				<input checked="" type="checkbox"/>	<input type="checkbox"/>
012345				<input checked="" type="checkbox"/>	<input type="checkbox"/>
012345				<input checked="" type="checkbox"/>	<input type="checkbox"/>

Opsætning		Send
Only send alarm if text has been entered	<input type="text"/>	<input type="checkbox"/>
Monitoring of detectors	<input type="checkbox"/>	<input type="checkbox"/>
Battery low warning	<input type="checkbox"/>	<input type="checkbox"/>
Only send wireless alarm every 15 mins.	<input type="checkbox"/>	<input type="checkbox"/>
Sound signal on alarm from wireless detector	<input checked="" type="checkbox"/>	<input type="checkbox"/>

6.7.7 Macros

Select 'Macros' and enter up to 2 help features in the device.

Macros are used as follows:

- Send the macro name as text message to the unit without a PIN code (e.g. HEAT ON)
- Call the device and dial the number of the macro (eg '1')
- In Profort's smartphone app: press the button, e.g. 'HEAT ON'

For multiple commands in the same macro, the separator is ';' (semicolon) without spaces.

Macros				
	Macro name	Commands	IR	Send
0	TEMP	V1 R	<input type="checkbox"/>	<input checked="" type="checkbox"/>
1	HEAT ON	S0	<input type="checkbox"/>	<input checked="" type="checkbox"/>
2	HEAT OFF	B0	<input type="checkbox"/>	<input checked="" type="checkbox"/>
3	EVERYTHING ON	S0;S1;S2;S3	<input type="checkbox"/>	<input checked="" type="checkbox"/>
4	EVERYTHING OFF	B0;B1;B2;B3	<input type="checkbox"/>	<input checked="" type="checkbox"/>

Set-up on masterview

In the case of heat pump control (models with IR transmitters), command 'MI heat pump name' (e.g. 'MI PANASONIC') is sent, then the heat pump functions will be entered as macros (e.g. M1 = H10, M2 = H16, M3 = H22 and M4 = OFF)).

6.7.8 Other

Select 'Andet' and program the unit as desired:

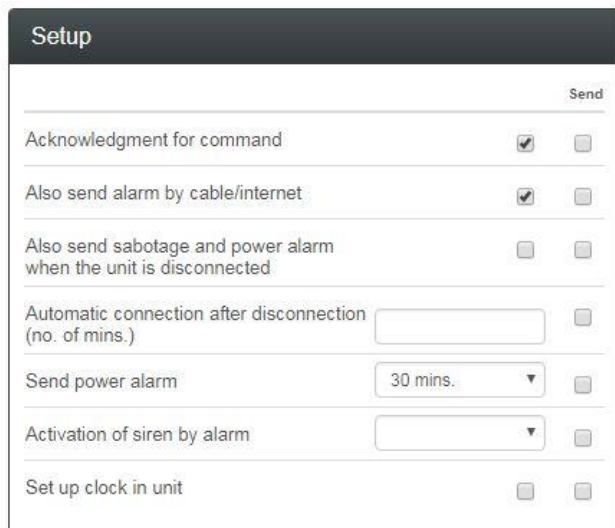

End with 'Save & Send'.

6.8 Save as template

If you want to use the current configuration for multiple units, you may want to save the configuration as a 'template'.

Click on the image of the unit, select 'Save as Template', fill in 'Name' and 'Description' and click 'Save':



6.9 Operation

Vælg 'Operate' in the sidebar on the left.

Here you can download different information from the unit. Communication between device and application is visible in Inbox / Outbox, just like text messages on a smartphone.

From the Command Line in the menu you can send your own commands, which are retrieved from the manual.

Set-up on masterview

The screenshot displays the Masterview application interface, divided into two main sections: 'Operate' and 'In/outbox'.

Operate Section: This section contains a list of queries under the heading 'Queries' with a 'Send' button. The queries are:

- Set up data connection via GPRS (with a 'Create' button)
- Retrieve version number
- Retrieve GSM signal strength
- Retrieve GPS position
- Retrieve status on inputs
- Retrieve status on outputs
- Retrieve number of pulses/minutes on input 1
- Retrieve number of pulses on input 2
- Retrieve number of pulses on input 3
- Retrieve value on analogue 1 (with an input field)
- Retrieve value on analogue 2 (with an input field)
- Retrieve value on analogue 3
- Retrieve value on analogue 1 (with an input field)
- Retrieve log (with an input field)
- Retrieve clock in unit

In/outbox Section: This section displays received messages. Three messages are visible, each enclosed in a colored box:

- Message 1 (green box): 1234 EA 123456 123456, 2016-08-29 16:40:55
- Message 2 (green box): 1234 EA 123456 123456, 2017-08-02 14:17:32
- Message 3 (blue box): 1234 V1 S -132 63;V1 M 2 30;V1 P;V1 A LOW TEMP;V1 L NORMAL TEMP;V1 B HIGH TEMP;M0 TEMP <V1 R>;M1 HEAT ON <S0>;M2 HEAT OFF <B0>;M3 EVERYTHING ON <S0;S1;S2;S3>;M4 EVERYTHING OFF <B0;B1;B2;B3>, 2017-11-17 13:15:45

Command line Section: This section has a 'Command line' header and a text input field containing 'Send inquiry via GPRS'. A 'GPRS' button with a cloud icon is located to the right of the input field.

All communication between device and application takes place by data (GPRS). If you want to disconnect the data connection when you complete the setup, send the command: 'EH'. Then the device no longer runs data (GPRS).

Remember next time to start communication with the unit by pressing 'Create' in Create Data Connection via GPRS.

Set-up via display

7 SET-UP VIA DISPLAY

(This chapter only applies to units with display).

The display works as a touch screen. To begin with you press the MENU button on the screen and you are directed to a keypad on which you need to type a password. In order to return to the standby image, press the ESC (short for ESCAPE) button.

The display menus are listed as follows:

Figure 7-1

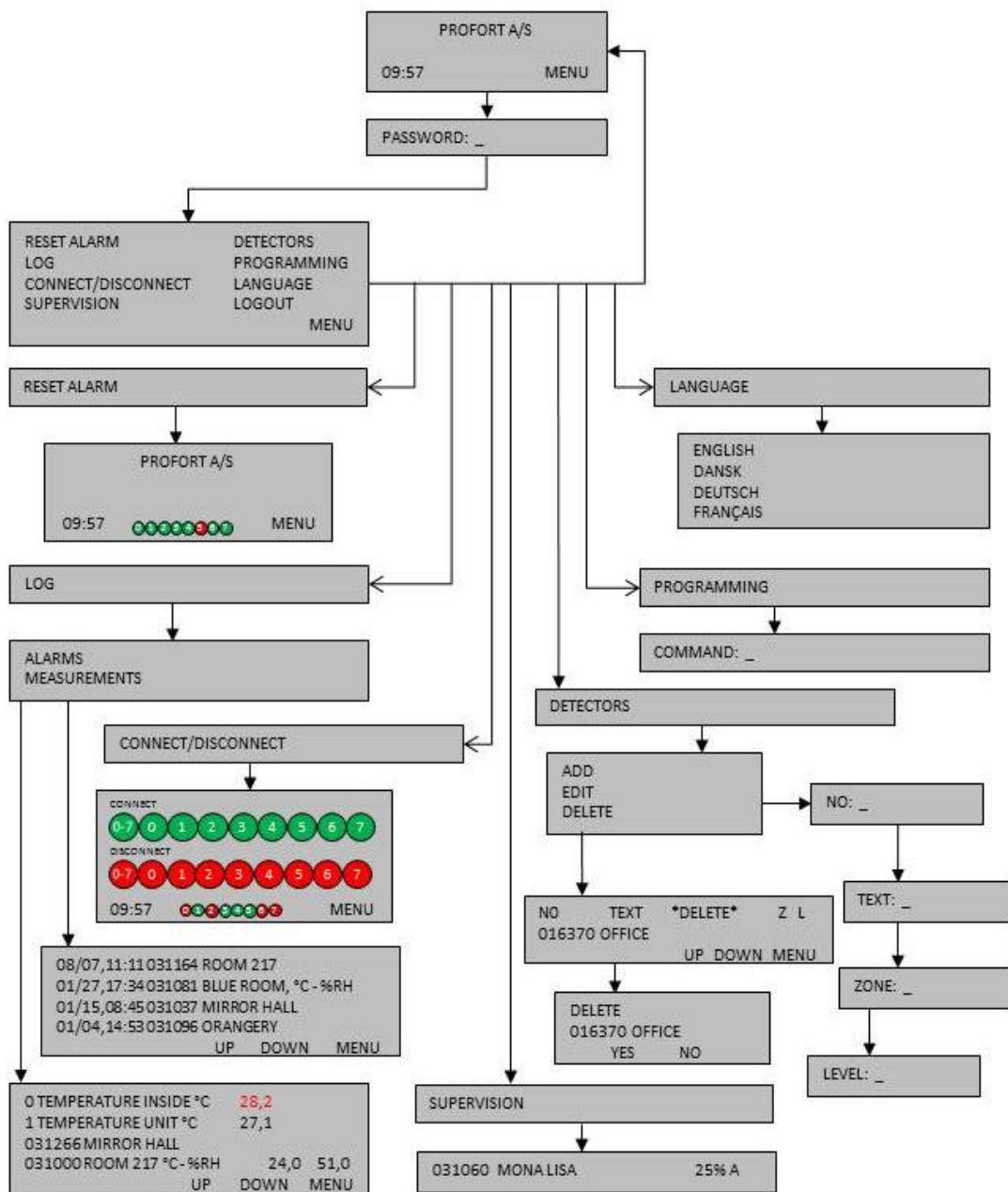

Set-up via display

From the display it is possible to manage e.g. the following:

- Access to the unit (Chapter 7.1)
- Add a name on the standby image (Chapter 7.2)
- Setting up the unit (Chapter 7.3)
- Resetting alarms (Chapter 7.4)
- Connection/disconnection of the whole central unit or of each of the 0-7 zones (see Chapter 10.1)
- Handle detectors and repeaters (Chapter 7.5)
- Monitoring of detectors (Chapter 7.6)
- See the latest 256 events and analog measurements in the log (see Chapter 14)

7.1 Access to the unit

In order to gain access to the menus of the display, you have to log in using an access code. The password is 1234 by default.

Log in

- Press MENU
- Enter the password of four digits
- Press ENT (short for ENTER)

In PASSWORD: _ it is not necessary to enter 1234, as the unit already knows the default access code 1234. Then skip item two and go directly to pressing ENT.

Logout

1. Press MENU
2. Press LOGOUT

Change password

1. Press MENU
2. Press PROGRAMMING
3. Enter N0 99999999 xxxx (N+zero, the telephone number of the unit, or if the unit has no SIM card mounted, any digit and new password with four digits)
4. Press ENT and the unit acknowledges by 'beep'ing three times.

User password

In order to limit the access to the display menu list, you may create password number two (user password).

1. Press MENU
2. Press PROGRAMMING
3. Enter TK xxxx (x = user password with four digits)
4. Press ENT and the unit acknowledges with three 'beeps'.

7.2 Add name in display

When the unit is powered, a standby image is shown and after approx. 20 secs. four 'beeps' sound. If the front is off the unit, a red diode may be seen lit up as a sign that the unit is connected and ready.

If you want a name on the standby image, e.g. the name of the museum, it can be added as follows:

1. Press PROGRAMMING
2. In COMMAND, the command LA followed by the new text are entered. Always remember a space after a command.
3. Press ENT and the unit acknowledges by 'beep'ing three times.

7.3 Set-up

The unit may be set up with various commands. See commands in Chapter 9.

1. Select PROGRAMMING
2. In COMMAND: _ use the keypad to enter the desired command
3. Press ENT and the unit acknowledges by 'beep'ing three times.

Example Engage battery check of detector:

1. Press PROGRAMMING
2. In COMMAND: _ enter FE
3. Press ENT and the unit acknowledges by 'beep'ing three times.

7.3.1 Set clock

Set the clock in the unit if you want indications of time or to use functions with time control. The unit may be put off without losing the time. An automatic backup saves the time for half an hour, if a battery has been mounted.

1. Press PROGRAMMING
2. In COMMAND: _ enter as follows: TM yy/mm/dd, hh:mm:ss

Example:

TM 12/06/20, 11:00:22

If a SIM card is mounted in the unit, it is not necessary to indicate time, since time in this case is automatically updated.

7.4 Reset alarm

An alarm may only be reset when you have logged in with a password.

1. Select RESET ALARM

When resetting an alarm, a possible siren or other alarm equipment, activated by a relay output, is stopped. You may, however, always stop the siren by pressing the clock in the left corner of the screen.

If you wish to reset an alarm in the display, send command 1234 RS to the unit.

7.5 Handling detectors and repeaters

From the unit display you may set, edit or delete a detector or repeater via the menu point DETECTORS.

For monitoring of wireless detectors, see Chapter 14 Log.

7.5.1 Create a detector or repeater

1. Start the detector by placing the battery within.
2. Press DETECTORS in the menu
3. Press ADD
Activate alarm from the desired detector. Check that the serial number (six digits) of the activated detector is shown in NO. If this is not the case, repeat the procedure.

Enter the information identifying each detector:

4. Enter a possible text in TEXT (max. 57 characters), e.g. a title or location. Text may be deselected by pressing ENT and continuing without writing a text. The page then changes to ZONE.
5. Enter a possible zone (with digits from 0-7). Press ENT to jump to LEVEL.
6. Level is only to be set, if the detector is seismic. The setting is valid for sensitivity and indicated with a digit from 0-5 (0 is lowest and = no sensitivity). If no digit has been noted, the default is five for highest sensitivity.
7. Press ENT to finish set-up of the detector. The central unit acknowledges with three 'beeps', and the information is saved.

7.5.2 Interrupt without updating

Entering of detector information may be interrupted without updating the information.

Wrong digits or letters may be corrected by one of two procedures:

1. Press ESC. You will return to the display menu without updating the information that you were entering.

Or...

2. Go to EDIT where you may edit the detector information.

7.5.3 Edit detector information

Go to EDIT to edit detector information.

1. Press DETECTORS.
2. Press EDIT.
3. Choose a detector no. and press it

Set-up via display

Use the UP and DOWN buttons to change pages, if there are more pages with detectors.

4. Use the keypad to write a text.
5. A detector may be attached to another zone (a zone with digits from 0-7). Press ENT to go to LEVEL.
6. Level for sensitivity of a seismic detector may be changed to a higher or lower sensitivity with a digit from 0-5.
7. Press ENT to finish editing. The unit acknowledges with three 'beeps', and the information is updated.

7.5.4 Delete a detector

1. Press DETECTORS in the display-menu.
2. Press DELETE
3. Select detector no. Use the UP and DOWN buttons to change page. Press the detector no. The text DELETE NO. YES NO is shown in the display.
4. Press NO to cancel the deletion, or press YES to delete.
5. The unit acknowledges with three 'beeps' and the detector has been deleted.

Notice: Only one detector may be deleted at a time.

If a detector has been deleted by mistake, the information has to be created again.

7.6 Monitor detectors

In the menu item SUPERVISION, all wireless detectors may be monitored. Each time the unit receives an OK signal, an alarm or an error message from a detector, the signal strength and a letter code are shown. The display can max. show 6 at a time.

If the unit is set to only send alarm if text has been created, you may only see the text defined detectors. Otherwise, all detectors are shown.

The detector is shown in the display with serial no., text, signal strength in percentage and type of alarm (A, I or O):

A = ordinary alarm

I = installation error ("I" is also shown if magnet sensor on the seismic detector combiSpot has not been activated)

O = OK

Example

031060 MONA LISA 25% A

The signal strength (in percentage) tells how powerful the signal strength of the detector is.

Use the commands

8 USE THE COMMANDS

Commands are used to operate and set up the device. Commands can be used for set-up and control through the display of the device, with SMS from a mobile phone, or in the command field at the main page in the Profort PC Program (see chapter -program

Figure 8-1).

Commands are also used to operate the device automatically. It is done by telling the unit what to do, for example upon an alarm from input, see examples in Chapters 5.6.1 and 5.8.1.

Commands In the Profort Web-program

Figure 8-1



All commands sent may be seen in the outbox under Files → Outbox:

Figure 8-2

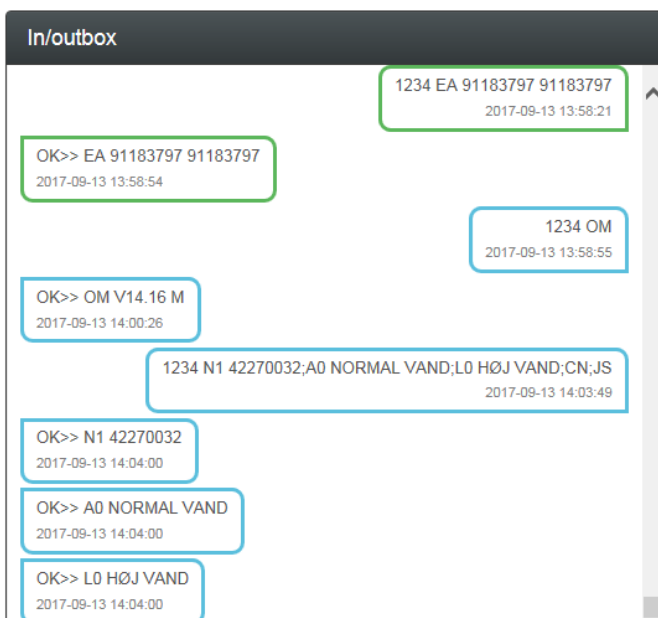

Commands with text messages

The unit can also be set up with SMS from a GSM mobile phone (Not applicable for units with only LAN connection.) In that case, the set-up is performed with commands.

Use the commands

An SMS command consists of the following:

- password of four digits *
- space *
- command of two characters
- space
- parameter as text

*) may be omitted if the password is deactivated.

NB! Each part of the command must be separated by a space.
The text can be of max. 64 characters. Spaces count as characters.

Example:

1234 A1 PUMP OFF Pin code (1234) + [space] + command (A1) + [space] + text (PUMP [space] OFF)

The command may be sent by text message to the unit telephone number. Both uppercase and lowercase letters may be used.

Set-up with (sms/text-message) commands

9 SET-UP WITH (SMS/TEXT-MESSAGE) COMMANDS

Note: all commands appear with the password 1234. Replace 1234 with your own password or exclude it, if you have deactivated the password on the SIM card.

All commands can also be used in the PC software command field and in the Web browser <http://setup.masterview.dk> . Just skip the password "1234".

You can find a further description of the features under the explanation of Profort PC Program in Ch. 5. The letter and number in the last column shows to which tab and in which region the content behind the command is described in the PC software. M1 refers to the tab Modem and area 1.

9.1 Password and id

Phone number of the unit: 1234 N0 99999999 (N0 = N + zero)	Defines the phone number of the unit, e.g. 99999999 (the number of the SIM card inside unit) Set-up of clock in the unit demands that the unit telephone number has been defined	M1
Password: 1234 N0 xxxxxxxx yyyy (N0 = N + zero)	Changes existing password to the unit. 1234 is present password, and yyyy = four digits chosen as new password. 99999999 is the unit telephone number and is at the same time defined as such	M1
ID code: 1234 N0 xxxxxxxx yyyy ID-TEKST (N0 = N + zero)	ID code is a general text (max. 32 characters) which is inserted in front of all messages from unit yyyy = four digits chosen as new password. (99999999 is the telephone number of the unit and is defined as such simultaneously)	M1
User password: (Only units with display) 1234 TK xxxx 1234 TK	Creates user password. xxxx = access code of your choice of four digits Deletes user password	T4

9.2 Receivers

Create receiver: 1234 N1 11111111 1234 N2 11111111 # (Only units with voice messages) 1234 N3 11111111 * 1234 N4 200 aaaa@bb.com 1234 N4 999 aaaa@bb.com	Creates alarm receiver (e.g. 11111111) in space no. 1 to receive alarms as text Note: The command for the first nine receivers is N1 to N9. Receivers 10 to 25 are named NA, NB, NC etc. Up to and including NP Creates alarm receiver (e.g. 11111111) in space no. 2 to receive alarm by voice message(#) Creates alarm receiver (e.g. 11111111) in space no. 3 to receive alarm by DTMF-tones Creates e-mail adress (e.g. aaaa@bb.com) to receive alarm (only on TDC network) Creates e-mail address (e.g. aaaa@bb.com) to send alarm from Profort unit to alarm receiver.	M2
---	--	----

Set-up with (sms/text-message) commands

	Applicable from SW version 14.27. The SIM card used must be opened for data and the unit programmed for data.	
Approved numbers: 1234 N5 11111111 +	Approved numbers (+) are the top security level of the unit. Approved numbers are the only ones allowed to contact the unit via text message (e.g. 11111111 in space no. 5)	M2
SIA-IP: N1 xxx.xxx.xxx.xxx:yyyyy	Space No. 1, sends alarm as SIA-IP protocol to a control center. SIA-IP can only be created in place no. 1 (not the LAN model). (Parameter: xxx.xxx.xxx.xxx = Control Center IP Number, yyyyy = Control Center Port Number. The two numbers must be separated by a colon. Also text message: NO 99999999 1234 ID NO N0 = (N + 0), 99999999 = telephone number of unit, 1234 = new password, ID number = subscription number at the control centre.) In order for the control center to recognize the unit, you get an ID number that you must define as the GSM unit ID. It is a prerequisite that you have an agreement with the control center, which also informs about the relevant numbers.	
Delete receiver: 1234 N1	Deletes alarm receiver 1. (N1..N9, NA(10), NB(11) etc. to NP(25))	M2
Create receivers in zone: 1234 01 11111111	Creates receiver (e.g. 11111111) in zone 0 in space 1. (zone = 0..7, receiver = 1..9, A(10), B(11)..P(25) Remember to create zone on input	M2
Example: 1234 34 11111111	Creates zone 3 in space 4 for alarm receiver 11111111	M2
1234 2B 11111111	Creates zone 2 in space 11(B) for alarm receiver 11111111	
Order of numbers: 1234 NO 321	Changes the order of numbers in the receiver file (0-9 and A-P). Calls will only be made for the indicated receivers and in the listed order, e.g. 3 first, then 2 and 1 last	M3
1234 NR	Deletes changed order of numbers in the receiver file. Alarm calls are once again sent from first to last recipient in the receiver file. (default setting)	
Send alarm to latest user: 1234 K1	Latest user receives alarm by text message	M3
1234 K2	Latest user gets alarm as voice message (Applies for units with voice message)	
1234 K3	Latest user gets alarm both by text messages and as voice message. (Voice message only applies for	

Set-up with (sms/text-message) commands

	units with voice message)	
1234 K0 (K0 = K + zero)	Deactivates Send alarm to latest user. (Default setting)	

9.3 Inputs

9.3.1 Digital input

Create digital input

Opened: 1234 A0 OPEN/BREAK TEXT 1234 A0	Codes the TEXT on open/break on input 0. Max. characters are 64 including spaces Deletes TEXT for input 0 in openbreak state	I1
Close/make: 1234 L0 CLOSE/MAKE TEXT 1234 L0	Creates the TEXT when input 0 is close/make. Deletes text for input 0 in close/make state	I1
Zone on input: 1234 A0 Z1 OPEN/BREAK TEXT 1234 L0 Z1 CLOSE/MAKE TEXT	Creates zone 1 and TEXT by open/break on input 0 Creates zone 1 and TEXT by close/make on input 0	I1
Input for connection/disconnection: 1234 RN 1234 RP 1234 RF	Sets input 0 (zero) to be used for disconnection/connection of the system (Level). Close/make state indicates disconnection Sets input 0 (zero) to be used for disconnection/connection of the system (Pulse) Deactivates connection and disconnection on input 0 (zero) to ordinary alarm input. Default setting	I3
Create filter and zone: 1234 A0 X1 OPEN/BREAK TEXT 1234 L0 X1 CLOSE/MAKE TEXT	Creates filter (X) and TEXT in zone 1 on open/break on input 0 Creates filter (X) and TEXT in zone 1 on close/make on input 0	I1

Input 1-3 as counter

Pulse count: 1234 C1	Sets input 1 to be used for pulse count (C1..C3)	I3
1234 C1 xxxxxx	Activates pulse counting. xxxxxx equals a start value between 0 and 999999. Enter e.g. 50, and the count will start at 50 pulses	
1234 L1 999999	Sets alarm limit=999999 for alarm on counter on input 1	I3

Set-up with (sms/text-message) commands

1234 L2 999999	Sets alarm limit=999999 for alarm on counter on input 2	I1
Minute count: 1234 UN	Activates and resets pulse counter on input 1	I3
1234 C1 M	Sets input 1 to minute counter	I3
1234 UM	Activates minute counter on input 1	I3
1234 C1 M xxxxxx	Activates count of minutes. xxxxxx equals a start value of 0 and 999999. Enter e.g. 50, and the alarm will go off after 50 minutes	
1234 UN 999999	Activates counter on input 1 with start value = 999999	I1
1234 UF	Deactivates pulse or minute counter on input 1	I3
Alarm input: 1234 C1 F	Deactivates pulse or minute count and sets input to ordinary alarm input. Default setting	I3
Pulse count, limit value and alarm text: 1234 L1 xxxxxx	When the pulse meter has been created with "UN" a limit value may be set and an alarm sent if the value is exceeded. The counter is reset after alarm. Sets the alarm limit (xxxxxx = 1-999999)	I1
1234 A1 TEXT	Alarm text is sent in case of exceeding the limit	

9.3.2 Analogue input

Scala: 1234 V1 S yyyy zzzz	Set up of the scale on analogue 1 (yyyy = minimum zzzz = maximum) for 0-10 V and for 0-20 mA. Min. and max. must be between -999 and 999. Decimal places are not allowed	I2
Points for the normal interval: 1234 V1 M yyyy zzzz	Setting up values for the normal interval (Point 1 and Point 2) on analogue input 1. If the value on the input is greater or smaller than yyyy (Point 1) or greater or smaller than zzzz (Point 2), an alarm is sent. E.g. 0 degrees in yyyy and 30 degrees in zzzz	
Alarm text : 1234 V1 A LOW TEXT	Low alarm TEXT on analogue input 1 is sent when the value becomes lower than the value defined in Point 1/yyyy (Vx M yyyy zzzz)	I2
1234 V1 L MEDIUM TEXT	Medium alarm TEXT on analogue input 1 is sent when the value becomes higher than the value defined in Point 1/yyyy or lower than the value in Point (Vx M yyyy zzzz)	
1234 V1 B HIGH TEXT	High alarm TEXT on analogue input 1 is sent when the value becomes higher than the value defined in Point 2/zzzz (Vx M yyyy zzzz)	

Set-up with (sms/text-message) commands

<p>Zone on analogue alarms: 1234 V1 A Z1 LOW TEXT</p> <p>1234 V1 L Z1 MEDIUM TEXT</p> <p>1234 V1 B Z1 HIGH TEXT</p> <p>1234 V1 P -0,5</p>	<p>Low alarm TEXT on analogue input 1 is sent to zone 1 when the value becomes lower than the value defined in Point 1</p> <p>Medium alarm TEXT on analogue input 1 is sent to zone 1 when the value becomes higher than the value defined in Point 1 or lower than the value in Point 2</p> <p>High alarm TEXT on analogue input 1 is sent to zone 1 when the value becomes higher than the value defined in Point 2</p> <p>Alarm when percentage deviation in the interval on analogue input 1. P = -10 - -0,5 (negative number with one decimal at the most) for the allowed percentage a level may decrease. And -0,5-99 (positive number with one decimal at the most) to reach the allowed percentage, a level may increase</p>	I2
<p>Create filter and zone: 1234 V1 A X1 LOW TEXT</p> <p>1234 V1 L X1 MEDIUM TEXT</p> <p>1234 V1 B X1 HIGH TEXT</p>	<p>Creates filter on analogue input 1 in zone 1 at low, middle and high level</p>	

9.3.3 Common for digital and analogue inputs

<p>Filter time: 1234 F2</p> <p>1234 F2 A</p>	<p>Creates filter time 20 secs. on all inputs with filter. F1 = 10 secs. (standard), F2 = 20 secs., F3 = 30 secs., F4 = 1 min., F5 = 2 mins., F6 = 4 mins., F7 = 8 mins., F8 = 15 mins., F9 = 30 mins., FP = 1 h(our), FQ = 2 hrs., FR = 4 hrs., FS = 8., FT = 16 hrs., FU = 32 hrs., FV = 64 hrs.</p> <p>Creates asymmetric filter time (F1...FV). Only for CLOSE function. When input is OPEN, the filter is active yet again</p>	I3
--	---	----

Voice message/DTMF

(Only for units with voice messages)

<p>1234 X9</p>	<p>Indicates 9 secs. (from 0-9) from telephone connection is established to the first DTMF-tone or voice message is sent. 0-9, default setting = 2 sek. If 0 is used, the unit awaits acknowledgement from the control centre before sending DTMF tone</p>	M3
----------------	--	----

Set-up with (sms/text-message) commands

Commands in text

<p>Command in text:</p> <p>1234 A1 TEXT <COMMAND></p>	<p>A command after the text is executed only when the device is connected. (Here COMMAND is carried out when input x is opened when the unit is connected)</p>	<p>I1 + T1</p>
<p>1234 A1 <COMMAND> TEXT</p>	<p>Commands placed in front of the text are executed even if the device is disconnected. (Here COMMAND is carried out when input x is opened when the device is connected as well as when it is disconnected.)</p>	
<p>Examples:</p> <p>1234 A1 <MA> ALARM</p>	<p>Sends the status of inputs with text when input 1 is opened. Command precedes the alarm text and is performed both when the device is connected and disconnected</p>	<p>I1 + T1</p>
<p>1234 A1 REPEAT <TP T 0001></p>	<p>Sends the alarm 'repeat' when input 1 is opened (A1), and set the timer to send status every quarter of an hour (<TP T 0001>). The command is placed after the text and is therefore performed only when the device is connected</p>	
<p>1234 L1 STOP REPEAT <TP></p>	<p>Stops the alarm with the message 'STOP REPEAT', when input 1 closes (L1), and deletes the timer settings (<TP>). Sending the status is hereby stopped. Is only performed when the device is connected</p>	

Send alarm

<p>Alarm only with text</p> <p>1234 CT</p>	<p>Sets the unit to send text from inputs where text on input has been created</p>	<p>I3</p>
<p>1234 CN</p>	<p>Sets the unit to send ID and text from inputs where text on input has been created</p>	
<p>1234 CF</p>	<p>Sets the unit to send alarm, even though text on input has not been created. (Default setting)</p>	
<p>Delay on connection/disconnection ('wait'):</p> <p>1234 A1 W0 TEXT</p>	<p>'W0' Delays the alarm for 30 sec. for input 1 at opening in zone 0 (W0-W7)</p>	<p>I1</p>
<p>1234 L1 W0 TEXT</p>	<p>'W0' Delays the alarm for 30 sec. for input 1 at closing in zone 0 (W0-W7)</p>	<p>I1</p>
<p>Pool alarms together (Only when using GSM):</p> <p>1234 DS</p> <p>1234 DM</p>	<p>Collects alarm messages so that several alarms from same digital input or wireless detector only causes one alarm message every 15 mins. Sends alarm immediately (default setting)</p>	<p>I3</p>

Set-up with (sms/text-message) commands

9.4 Outputs

<p>Automatic alarm: 1234 G2</p>	<p>Activates (closes) automatic relay outputs at alarm on inputs. (G1 = 10 secs., G2 = 20 secs., G3 = 30 secs., G4 = 1 min, G5 = 2 mins, G6 = 4 mins, G7 = 8 mins, G8 = 15 mins og G9 = indefinite, G0 = no activity).</p> <p>If relay outputs are to be opened, the relays are closed beforehand by activating the command S0 (output zero), S1-S7 for other relays</p>	<p>U3</p>
<p>Show connection and disconnection: 1234 QN</p> <p>1234 QF</p>	<p>Sets the output to show the state of zones. Output 0 will close when the system is connected and open when the system is disconnected (default).</p> <p>If no zone has been indicated in the set-up only output 0 is activated.</p> <p>If relay outputs are to be opened, the relays are closed before by activation with the command Sx (x = 0-3, if the unit has four outputs)</p> <p>Relays do not show state of zones. Default setting</p>	<p>U3</p>
<p>Pulse on output: 1234 P0</p>	<p>Sets output 0 to pulse (one shot) for 10 secs. (Default setting.) P1-P7 for other relays</p>	
<p>Variable pulse length: 1234 Q2</p> <p>1234 Q1</p>	<p>Sets pulse length (P0) to 20 secs. (Q3=30 secs. Q4=1 min. Q5=2 mins. Q6=4 mins. Q7=8 mins. Q8=15 mins. Q9=30 mins.)</p> <p>Reverses pulse length (P0) to 10 secs.</p>	
<p>Combine alarm and connection/disconnection: 1234 G2 og 1234 QN</p>	<p>Combines activation of outputs at alarm on zones with display of connection/disconnection</p>	<p>U3</p>
<p>Outputs follow inputs: 1234 GA</p> <p>1234 G0</p>	<p>Indicates that outputs follow the corresponding inputs if text has been created. Alarm on analogue input activates relay 1.</p> <p>The command 1234 GA may not be used with 1234 QN ("Outputs show connection/disconnection")</p> <p>Cancels outputs follow inputs</p>	<p>U3</p>
<p>Enable/disable output functionality:</p> <p>Applicable for units versions: 14.18 or newer</p>	<p>In certain applications it is advisable to restrict user access to set/break/pulse/tilt on device output relays. E.g. port opening in conjunction with Macro activation. It is possible to combine all combinations of outputs, regardless of multiGuard model. Non-existent physical outputs are "virtually" available and are only used internally in multiGuard software. A maximum of four "&" commands can be performed. If just one output is deactivated, ??>> S0&2&4&7&5 is returned!</p>	

Set-up with (sms/text-message) commands

1234 S0&2&4&7&5	<p>Output 0 is only closed/made provided outputs 2, 4, 7 and 5 are all closed/made.</p> <p>Output 0 is only opened provided output 1 is already closed/made.</p> <p>Output 1 will be pulsed if output 0 is already closed/made.</p> <p>Output 3 changes status (tilts), if output 7 is already closed/made</p>	
1234 B0&1		
1234 P1&0		
1234 J3&7		

9.5 Voltage

<p>Voltage:</p> <p>1234 WN</p>	<p>Sets inputs to activate at 24 V (only applicable for units activated by 24V)</p> <p>NB! At 24VDC, the input texts are switched, i.e. input open means input closed and vice versa</p>	I3
1234 WF	Sets inputs to activate at GND (default setting)	
<p>Power saving:</p> <p>1234 DN</p> <p>1234 DF</p> <p>1234 DB</p> <p>1234 DE</p>	<p>Some models can be set up to run in power saving mode. The device must be supplied with a battery and disconnected from external power. It must not be connected with a serial cable.</p> <p>In the power saving mode the GSM modem will go into hibernation mode and automatically wake of hibernation for one minute each hour.</p> <p>Alarms from inputs and power failure will be sent at once but the device only responds to text message commands once every hour</p> <p>Activates power saving mode</p> <p>Disable power saving mode (default setting)</p> <p>Enables enhanced charging to approx.. 4,1 V</p> <p>Deactivates enhanced charging</p>	Command line

9.6 Wireless detectors

(Only for units with wireless interface)

Create detector

<p>Create detector:</p> <p>1234 DT 111111 TEXT</p>	<p>Create detector no. 111111 with the chosen TEXT (max. 57 characters). Detector no. is shown on the detector</p>	T1
--	--	----

Set-up with (sms/text-message) commands

1234 DT 111111	Deletes text for detector no. 111111	
TL 1234 111111 ALARM	Wireless alarm from e.g. detector no. 111111 - with the text 'ALARM'	
Zone: DT 111111 Z1 TEXT	Z1 in the beginning of the text indicates that the input belongs to zone 1. (Z0..Z7)	T1
Alarm only if text: 1234 CT 1234 CN 1234 CF 1234 CB	Sets the unit to send created text from detectors Sets the unit to send ID, detector no. and created text Sends alarms, although text is not created. (Default Setting.) Sends alarms, even though text is not created. Stops if no OK signal has been received after 30 mins.	T2
Await alarm ('wait'): 1234 DT 111111 W0 TEXT	Writing W0 before the text indicates that the alarm from detector no. 111111 is only sent after 30 secs. in zone 0. (W0..W7)	T1
Sound by alarm: 1234 HN 1234 HF	Activates sound signal from the central unit when the wireless detector releases alarm. (Default setting.) Deactivates sound signal by activation of wireless detector	T2
TA 9999	Change password in wireless unit	
Sensitivity ('Level'): 1234 DT 111111 50 TEXT	By writing 50 before the text (5+0) specifies the sensitivity of the wireless seismic detector to be 5 and zone to be 0 (00, 10, 20, 30, 40, 50. 50 is the highest sensitivity (default setting), and 00 means not activated)	T1

Monitoring

Malfunctioning 1234 FN	Creates monitoring of detectors and makes sure that malfunctioning are communicated to receiver	T2
1234 FF	Deactivates monitoring of detectors. (Default setting)	
Battery: 1234 FB	Creates monitoring on low battery level on detectors	T2
1234 FE	Deactivates monitoring of low battery on detectors. (Default setting)	
Signal strength: 1234 VT	Signal strength, number and texts on wireless detectors are sent to RS232 and to the receivers on the GSM list	

Set-up with (sms/text-message) commands

1234 VP	Shows signal strength and type of data as well as measurements on climaSpot and luxSpot. NB! Only applicable for Piccolo Light Server with ethernet Stops sending of signal strength to RS232 and to the receivers on the GSM list	
1234 VF		
Function jamming: YES X X = 0-5 5 is 6 seconds 4 is 12 seconds 3 is 18 seconds 2 is 24 seconds 1 is 30 seconds 0 is none	Sensitivity to jamming X = 0-5 5 is 6 seconds (standard) 4 is 12 seconds 3 is 18 seconds 2 is 24 seconds 1 is 30 seconds 0 is none	

Analogue detectors

Wireless temperature (Create the detector first): 1234 D1 111111 S 0 0 1234 D1 111111 S -24 70 1234 D1 111111 M z y 1234 D1 111111 M 1234 D1 111111	Activates temperature measurement in climaSpot with detector no. 111111 Activates temperature measurement in flexSpot 111111 Activates temperature alarm (if temperature exceeds the limits for normal interval). z = lowest and y = highest limit temperature in the normal range Deactivates temperature alarm. Measurements are now solely used for logging Deletes temperature set-up on detector 111111	T1
Text temperature alarm: 1234 D1 111111 A TEXT 1234 D1 111111 L TEXT	Creates TEXT to be shown at temperature alarm Creates TEXT to be shown when temp. is back in the normal range	T1
Wireless humidity and other analogue measurement (Create the detector first): 1234 D2 111111 S 0 0 1234 D2 111111 S z y	Activates humidity measurement in climaSpot with detector no. 111111 Activates humidity and other analogue measurement in flexSpot z = minimum value and y = maximum value for analogue measuring equipment, e.g. PT1000: z = -248 and y = 499. For luxSpot: PT1000: z=0 og y=0357.	T1

Set-up with (sms/text-message) commands

1234 D1 111111 S 1 1	Activates temperature measurement in climaSpot with Profort PTC for detector 111111	
1234 D2 111111 S 2 2	Activates conductivity measurement in climaSpot with wooden block for detector 111111	
1234 D2 111111 K z	Defines factors for volt and mill amperes. 0-10 V: z = 937 0-20 mA: z = 900	
1234 D2 111111 K	Deletes factors for volt and mill amperes	
1234 D2 111111 M z y	Activates humidity and other analogue alarm (if humidity exceeds the limits for the normal range). z = lowest and y = highest limit for humidity in the normal range	
1234 D2 111111 M	Deactivates humidity and other analogue alarm. Measurements are now solely used for logging	
1234 D2 111111	Deletes the setup for humidity and other analogue measurement on detector xxxxxx	
Text humidity and other analogue alarms: 1234 D2 111111 A TEXT	Creates TEXT to be shown at humidity and other analogue alarms	T1
1234 D2 111111 L TEXT	Creates TEXT to be shown when humidity or other analogue measurements again are within the normal range	

9.7 Macro with commands or infrared

Precoded heat pump functions (v.12.54): 1234 MI heat pump name	Retrieves IR codes for heat pump from the unit's own archive. Only applicable for units with the option of IR-codes (from v.12.08)	A4
Macro: 1234 M1 NAME <COMMAND>	Registers macro 1 (M0..M19, (M0-M9 for Remote LAN)) with the name NAME and carries out the command.	
1234 R1 NAME <COMMAND>	More commands are separated by semicolon ';' without space.. <i>Example:</i> 1234 M0 PULSE5 <S0;PS 5;B0>	
1234 M1 NAME	Creates macro no. zero with the name "PULSE5", which draws output 0 for 5 secs.	
1234 R1 NAME	Macro 1 (M0..M19) with the name NAME is now made ready to receive IR codes from a remote control – Note that no commands is being set here.	
	When the device's red diode flashes quickly: turn the remote control towards "IR in" and press with the desired functions for 30 sec. The diode lights up briefly and then flashes normally. Now is macro x saved with an infrared code	

Set-up with (sms/text-message) commands

1234 NAME	Activates the macro named NAME. The macro will now execute commands or play the IR codes. Macros are accepted without password
1234 M1	Deletes macro 1 (M0..M19).
1234 R1	Deletes macro 11 (R0..R9)

9.8 Internet

Access: 1234 EH USER NAME	Creates USERNAME in the unit for GPRS access. It is a condition, that the unit telephone number (N0) has been defined	A3
1234 EA USERNAME 12345678	Activates access to the internet with USERNAME and creates N0. (12345678 = Telephone number of GSM unit)	
1234 EH	Deactivates access to the Internet	
1234 EG access_point_name	Defines the APN for the Internet connection. 'internet' as APN is default setting. E.g. 1234 EG INTERNET	
1234 EG APN user password 1234 ED 123456	Defines the APN, user and password for the internet connection. Sets USER NAME and ID number in model LAN	
Own server: 1234 EI SERVER NAME	Sets the unit for handling on other server by GPRS access. (www.multiguard.dk is standard)	
1234 EI 123.456.789.123	Sets the unit for specific IP address by GPRS access	

9.9 Time features and clock functions

Time

Create clock: 1234 TM	Automatically creates the clock in the unit. The unit sends an SMS to itself and uses the actual time. It is required that N0 (N + zero) has been defined: (1234 N0 xxxxxxxxx)	A1
1234 TM YY/MM/DD,HH:MM:SS	Creates clock in the unit manually. The unit uses the time indicated. Enter year/month/date,hour:minute:second – all with two digits	
1234 TR	Returns the time of the unit	
1234 TF	Deletes clock from the unit	

Set-up with (sms/text-message) commands

Timer and status (status is sent to those on receiver list)

<p>Timer: 1234 TP W 1200 <xx;zz> (If <xx;zz> is omitted then commands are not sent, but status is sent to receiver)</p> <p>TP W status weekly, Wednesday TP D status daily TP T status every 15. mins. TP M status after minutes TP P return counter and reset</p>	<p>Codes the timer to execute command xx and zz weekly at 12:00. If command field is omitted the status for all inputs is sent by text message.</p> <p>W= weekly (Wednesdays), D= daily and 12:00 is the time . T= no. Of 15 mins., M= no. Of mins. and 1200 is the number between activations.</p> <p>y= Hour+minute <zz=kommando> y= Hour+minute <zz=kommando> y= number periods <zz=kommando> y= number of mins.<zz=kommando> y= Hour+minute <zz=kommando> (v. 12.04)</p> <p>At 'Weekly' (always Wednesday) and 'Daily' is indicated by HHMM (time with hour and minutes). At 'No. of 15 minutes' is indicated the number of 15 minutes between activations, e.g. 0004 for each hour. 'Minutes' is stated with no. of minutes between activation, e.g. 0010 for each 10 minutes..</p> <p>zz = command. E.g. MA D0 ;MA A1 to get status at the digital input zero (MA D0) and the analogue input 1(MA A1), respectively.</p> <p>Note: the unit phone number and time need to be defined: 1234 N0 nnnnnnnn</p>	<p>K3</p>
<p>1234 TU</p>	<p>Sets the timer to run indefinitely (default)</p>	
<p>1234 T1</p>	<p>Codes the timer to activate 1 time (T1..T9)</p>	
<p>1234 T0 (T0 = T + nul)</p>	<p>Stops/deactivates the timer</p>	
<p>1234 TP P_1230</p>	<p>Read counter value on input daily, e.g. 12:30, to those on the receiverlist, and resets counter</p>	
<p>1234 TP</p>	<p>Deletes timer settings</p>	

Time control

<p>Automatic connection/disconnection 1234 TI 0800 1600</p>	<p>Creation of automatic connection and disconnection of system between 08:00 and 16:00. 0800 indicates the time for connection and 1600 the time for disconnection. Notice that time for disconnection is optional. The unit flashes red three times if the number is unknown (N0), once in connected and off in disconnected mode</p>	<p>K2</p>
--	---	-----------

Set-up with (sms/text-message) commands

1234 TI	Deletes settings for automatic connection and disconnection	
Time control of relay: 1234 IU HHMM hhmm	Activates an interval for time control of output. Closes output at 'TT:MM' and opens at 'TT:MM'. Remember to define which output you need time controlled (1234 IG x, see below)	
1234 IU HHMM hhmm HHMM hhmm	Activates two intervals for time control of output. Remember to define which output you need time controlled (1234 IG x, see below)	
1234 IU	Deletes time control of all outputs	
Define output for time control: 1234 IG 0	Defines output 0 for time control. Time control can apply for more than one output at a time	
1234 IH 0	Deletes time control of output 0	
Alarm for missing activity: RO 1100 <MA D1>	Sends alarm for missing activity (multiGuard® Senior only). Code e.g.. A1 NO MOVEMENT and activate command e.g. 10:00 AM. If there is no movement before 11:00 PM, the alarm text is sent to input 1.	

Calendar

Specific date: 1234 TS DDMMYY HHMM <COMMAND;COMMAND>	Execute command(s) on date: ddmmyy, time hhmm. NB: The activity is deleted automatically when the time comes	K1
Daily: 1234 TS D HHMM <COMMAND;COMMAND>	Execute command(s) every day at hhmm (time). Example: TS D 0700 <P0> activates output 0 for 10 sec. every day at 7.00 pm	
Weekly: 1234 TS M HHMM <COMMAND;COMMAND> 1234 TS T HHMM <COMMAND;COMMAND> 1234 TS O HHMM <COMMAND;COMMAND> 1234 TS R HHMM <COMMAND;COMMAND> 1234 TS F HHMM <COMMAND;COMMAND> 1234 TS L HHMM <COMMAND;COMMAND> 1234 TS S HHMM <COMMAND;COMMAND>	Execute command Mondays at hhmm Execute command Tuesdays at hhmm Execute command Wednesdays (O) at hhmm Execute command Thursdays (R) at hhmm Execute command Fridays at hhmm Execute command Saturdays (L) at hhmm Execute command Sundays at hhmm	

Set-up with (sms/text-message) commands

Delete activities: 1234 TS DDMMYY HHMM 1234 TS D HHMM 1234 TS x HHMM 1234 P#	Delete specific activity Delete daily activity Delete weekly activity (x = M, T, O, R, F, L, S) Delete all calendar settings	
Read calendar activities: 1234 PR K	Returns all activities in the calendar to the requestor.	

9.10 System messages and –alarms

Messages

Message at connection and disconnection: 1234 EN 1234 EF	The unit sends a message to alarm receivers at connection/disconnection	M3
	The unit does not send a message to alarm receivers at connection/disconnection. Default setting	
Acknowledgement: 1234 KN 1234 KS 1234 KF	The unit acknowledges each new command. Default setting	A1
	If several commands are sent simultaneously, only the first command will be acknowledged	
	Deactivates 'send acknowledgment' by new command	
Cable/internet: 1234 KB 1234 KE	The unit sends an alarm via RS232 or GPRS (default setting).	
	The unit does not send an alarm via RS232 or GPRS	
Display: 1234 LA TEXT	Codes the TEXT to be shown on the display of the unit (max. 38 characters). Default text is "NO ALARM"	A2

System alarms

Sabotage, system: 1234 YN 1234 YF	Sabotage/power alarms are also sent when the system is disconnected	A1
	Sabotage/power alarms are not sent when the system is disconnected. Default setting	
1234 L9 TEXT	Codes the TEXT to be shown at sabotage on the unit (max. 64 characters). Default text is 'SABOTAGE'	A2
1234 A9 NO TIME	Text when own number is missing and clock is activated	
1234 B9 NO TIME	Message if no clock in unit	

Set-up with (sms/text-message) commands

Sabotage, zone: 1234 S9 TEXT	Answer when sabotage, sent to receivers in zone 0	
1234 YN Z1	Sabotage/power alarms from zone 1 are also sent when zone 1 is disconnected. (Z0..Z7)	
1234 YF Z1	Sabotage/power alarms from zone 1 are not sent when zone 1 is disconnected. Default setting. (Z0..Z7)	
Power failure: 1234 JM	In case of power failure, the power alarm is sent after 30 min., after which the unit closes down. Requires a rechargeable battery. Default setting	A1
1234 JS	In case of power failure, the power alarm is sent immediately (after app. 10 sec.), and the unit is supplied by battery for 30 min., after which the unit closes down	
1234 A8 TEXT	Codes the TEXT to be shown at power failure. Default text is 'POWER FAILURE' (max. 64 characters)	A2
1234 B8 POWER FAILURE	Answer from unit in case of power failure sent to receivers in zone 0	
1234 S8 POWER OK	Answer when power is present	
1234 L8 TEXT	Codes the TEXT to be shown when power is present. Default text is 'POWER OK' (max. 64 characters)	A2
1234 S8 TEXT	Answer from unit when power is present sent to receivers in zone 0	
1234 JF	The device does not send alarm in case of power failure	A1
1234 DM	Sends alarm message every 15. mins. To be used with PIR (motion sensor) which sends alarm continuously when movement	
1234 DS	Sends alarm message immediately (default setting)	

Siren

Siren: 1234 H1	Activates the siren (at alarm on inputs) and sounds for 10 secs. (H1 = 10 secs., H2 = 20 secs., H3 = 30 secs., H4 = 1 min., H5 = 2 mins., H6 = 4 mins., H7 = 8 mins., H8 = 15 mins. og H9 = infinitely)	A1
1234 H0 (H0 = H + Zero)	Does not activate siren at alarm. Default setting	

Set-up with (sms/text-message) commands

9.11 Restore factory settings

If it is necessary to delete all settings and voice message in the unit, the following command may be used:

1234 P!**BEWARE** – Deletes all! But retains original macros for heat pump control.

10 OPERATION

Operation covers the following:

- Connection and disconnection of the unit.
- Control of relay outputs
- Interrupt further alarms
- Inquiries to the unit
- Macro execution
- Text to and from a serial port (RS232 to e.g. PLC)

10.1 Connection and disconnection of the unit

In disconnected state the unit will not send alarms, and the outputs are not activated as a consequence of activity on inputs.

NB: If the unit has been set with a command in the beginning of text field (see chapter 5.6.1 page 37), instructions will also be carried out during disconnection.

Connection and disconnection with text messages:

1234 ON	Connects the unit. Alarm is sent to the receivers. Four 'beeps' will sound from the unit, and a red diode flashes. Resets all outputs at the same time
1234 OF	Disconnects the unit. Alarm is not sent to the receivers. Two 'beeps' from the unit and red diode turns off
1234 ON Z1	Connects zone 1 (0..7). Alarms in zone 1 are sent to receivers of zone 1. Four 'beeps' from the unit and a red diode flashes
1234 OF Z1	Disconnects zone 1 (0..7). Two 'beeps' from the unit and red diode turns off
1234 OV	(Applies to units with wireless interface) Connects the unit. After eight minutes the status of the detectors is sent. Compares with status of the time, when the central unit was last disconnected
1234 OS	(Applies to units with wireless interface) Connects the unit. After eight minutes, the unit sends status of the detectors and shows which detectors are active
1234 OA 10	Activates limited disconnection for 1-30 mins. (01..30). The unit automatically connects all zones after 'mm' minutes. 'mm'=1-30. 'mm'=0 deactivates the function
1234 OA	Deactivates limited disconnection. Default setting

Connection and disconnection from display

Connection and disconnection may be used on both the unit itself and on each zone. CONNECTION is the green circles. DISCONNECTION is the red ones.

Connect and disconnect the unit::

1. Press MENU
2. Press CONNECTION/DISCONNECTION

Operation

3. Select CONNECTION or DISCONNECTION by pressing the green or the red circles on which it says 0-7.

Connect and disconnect zone:

1. Press MENU
2. Press CONNECTION/DISCONNECTION
3. Choose to connect or disconnect a zone by pressing the green or red circles.

Notice: If e.g. zone 3 is disconnected, this is seen on the display in standby state by a red no. 3 in the row of eight green zones. This is, however, only the case if you are logged in.

10.2 Control of relay outputs

The eight outputs are default opened and may be closed or opened by a command, text message or DTMF tones. Exceptions are:

1234 Gx activates outputs when an alarm is released (the relay will change position at alarm).

1234 GA where output reflects input (relays will follow inputs).

Control of relay outputs with (SMS/ text message) commands:

1234 S0	Closes output 0 (S0..S3, if the device has four outputs)
1234 B0	Opens output 0
1234 S0 P	Closes output x app. 10 secs. (pulse)
1234 B0 P	Opens output x app. 10 secs. (pulse)
1234 P0	Output 0 changes stage (pulses) for approx. 10 secs.
1234 J0	Output 0 changes state (tilts)
1234 PS 10	Pauses between commands for 10 secs. (01..99) NB: the unit WILL NOT receive alarm in this interval!!!

Control of relay outputs with DTMF:

1. Call the unit
2. Await 1 tone
3. Enter password (e.g.. 1234)
4. Await 2 tones
5. Enter no. of the command you wish to carry out (see table to the right)
6. If required, repeat step 4+5
7. Hang up

*00	Pulses output 0 for 10 secs. (*00..*03, if device has four outputs)
*10	Opens output 0
*20	Closes output 0
*30	Opens output x for 10 sec. (pulse)
*40	Closes output x for 10 sec. (pulse)
*50	Changes state on output 0
0	Executes macro 0 (0..9)

10.3 Interrupt further alarms

Enter # immediately after playing the voice message and hearing the sound of the 'beep'. Subsequent telephone numbers in the list of receivers are not alerted (Not all models have voice messages).

Operation

10.4 Inquiries and commands to the unit

Inquiries are used to gather information from the unit. The response on inquiries is sent to the mobile phone that sent the message. All commands can also be used in the PC software command field and <http://setup.masterview.dk>. Just skip the password "1234".

Inquiries to the unit by (text message) commands

1234 MO	Indicates status of all outputs. Only to the mobile telephone that sends the inquiry
1234 MR	Indicates status for inputs with text created. Only to the mobile telephone that sends the inquiry
1234 MA	Simulates alarm and activates commands on inputs with text encoded. Returns to all receivers
1234 PL	States the last 10 events in the log. I.e. alarms gone in/data and sent commands. NB: Returns with one event in each text message = 10 texts
1234 PL 20	States the last 20 events in the log (1..256). I.e. alarms gone in/data and sent commands. NB: Returns with one event in each text message = 10 texts
1234 PL A	States all events in the log (256 lines). I.e. alarms gone in/data and sent commands. NB: Returns with one event in each text message = 256 texts
1234 V1 R	States the latest measurement from analog input 1
1234 PA	Returns analogue measurements to the PC-program
1234 PA xx	Returns analogue measurements to the PC-program., xx = number of days back in time
1234 PA DDMMYY DDMMYY	Returns analogue measurements to the PC-program.. First date is 'from DATE' and last is 'to DATE', which can be omitted
1234 PA DDMMYY	Transfers analogue measurements from date, month, year (v.12.20)
1234 D1 111111 R	States temperature on detector no. 111111
1234 D2 111111 R	States humidity or other analog value on detector no. 111111
1234 OK	States signal strength on the GSM net. If the signal strength is below 25%, you should use an extra antenna
1234 OM	States the version number (model) of the unit
1234 OR	Informs status on connection/disconnection. Returns e.g. OR +++-+- ++
1234 OG	States GPS position (v.12.23→)
1234 OP	States position (GSM cell-ID and distance) e.g. '32d6 TA:3' TA states the signal strength (v.12.16→)
1234 PR	States all of the unit set-up. Default texts are not returned
1234 PR I	States IR codes installed (If using text message, R1-R9 is entered)
1234 PR O	States set-up of inputs and outputs. Receivers and texts are not returned
1234 PR N	States the receiver list
1234 PR M	States all macros and associated command names, e.g. M1 OFF
1234 PR T	States all texts on inputs in the unit (digital/analogue). Including default texts
1234 PR K	States all activities in calendar
1234 UL	States the number of pulses on input 1

Operation

1234 C1 R	States the number of pulses on input 1 (C1..C3)
1234 UN	Resets pulse count on input 1
1234 C1 N	Resets pulse count on input 1
1234 C1 N 5412	Activates pulse count on input 1 with initial value 5412
1234 P-	Deletes the setup in the unit
1234 P%	Deletes analogue measurements
1234 P#	Deletes calendar settings
1234 P&	Deletes event log
1234 P/	Deletes all wireless remote controls created
1234 P!	Deletes setup and reinstalls default setup

Inquiries to the unit with the pc program:

From the main page, press "Send inquiry" and the following display is shown:

Figure 10-1:

<http://setup.masterview.dk>

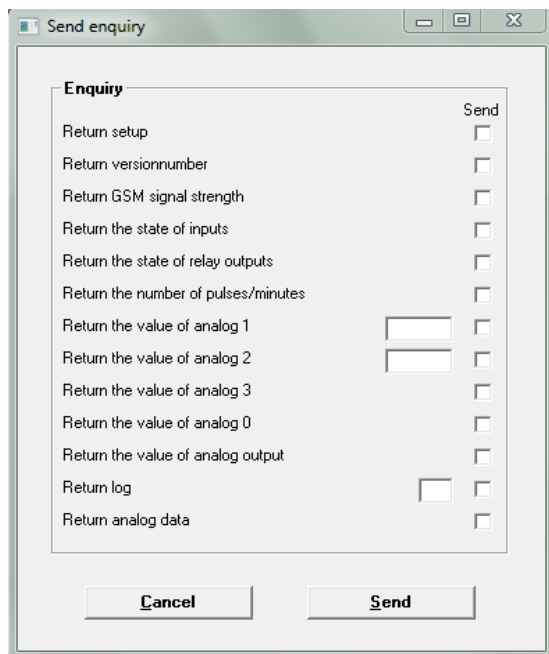

Mark the information, you want, and press Send.

In case of 'Return value of analog 1 or 2', you ask for the present status. Returns value of a specific detector (6-digit serial number to be written in the field) or a wired analog input (only check mark under 'Send' while the field is empty).

On climaSpot and climaSpot IP65, 'analog 1' is: Temperature, and 'analog 2': Humidity. On flexSpot, 'analog 1' is: Temperature and 'analog 2': 0-10 V, 0/4-24 mA, PT-1000.

Operation

At 'Return log' you must either tick 'Send' and get a log of the 10 latest events, or choose how many events you want to be shown by writing the desired number in the field before 'Send'.

At 'Return analog data', you must read the returned information by going to Files → Analog measurements. This log may be transferred to MS Excel. All other data is shown in the inbox on the main page.

Inquiries to the unit from display

(Only units with display)

It is possible to send an inquiry to the unit, e.g. to get an answer to the signal strength of the GSM net by the command OK.

Example, show GSM signal strength:

1. Press MENU
2. Press PROGRAMMING
3. Type in the letters OK under COMMAND
4. Press ENT and the unit acknowledges by 'beeping three times.

10.5 Macro execution

A created macro is activated by text message or by telephone call and DTMF.

Example:

Macro 1 has been created with the name 'PULSE5' which pulls output 2 for five sec. The macro has been created with the following text message content: `1234 M1 PULSE5 <S2;PS 5;B2>`

Activate macro with text message: `1234 PULSE5`

Activate macro with call and DTMF:

1. Call the unit
2. Enter password (e.g. 1234)
3. Await 2 tones
4. Enter `x` (x = macro number 0-9)

10.6 Text to and from a serial port (RS-232)

If the unit is not set up for data by EH user name, it will always be active and ready for serial data communication.

If the unit has been set up for GPRS data, AT needs to be sent from PLC for every 15. Minutes. End with CTRL F.

Failure to do so will stop the RS-232 data communication.

The answer signal from the unit will look similar to this: AT 14.2 175MG.

Receive text from PLC

If an ASCII-text sequence from a PLC ends with CR+LF (max. 160 characters) the text will be sent as text message to all receivers in zone 0.

Important: PIN code must be enabled on SIM card!

Receive command from PLC

If a text starts with PIN code, e.g. "1234", the following will be perceived as a command.

1234 N1 12345678 Codes receiver no. 1 to telephone number 12345678.

Important: PIN code must be enabled on SIM card!

Send text to PLC: 1234 TX TRANSFER THIS TEXT

A text sequence 'TRANSFER THIS TEXT' which ends with CR+LF will be transferred with 9600 baud to e.g. a PLC on RS232.

Data communication with PLC

With a GSM modem connected to a PC the unit will be able to send and receive data from a PLC when the call is made as 'data call'. Can be used e.g. with the program Hyper Terminal.

10.7 GPS

In the PC program, press 'Send inquiry', whereby a window pops up; press 'GPS position'. Tick the box and press 'Send', and a map from Google Maps will appear, showing the GPS position. It is also possible to send the command OG to see the Google Maps image.

11 INTERNET

The unit can be controlled over the Internet at www.profort.com. Here, you may register as user and have an area assigned to your unit(s).

In order to use the Internet for monitoring and control it is required that your computer has a connection, and that the GSM unit has been set to the Internet (for Internet settings on the PC see "Connection via the internet" and "Username on the internet" on page 28 as well as GPRS page 48).

Activate with text message

1234 EH USER NAME activates access to the internet. (It is a condition that the unit telephone number (N0) has been created).

1234 EA USER NAME xxxxxxxx activates access to the internet and creates N0 (xxxxxxx = telephone number of GSM unit).

USER NAME is what you want to log on to the Internet with. Normally the username is the telephone number of the unit, which is N0. This may also consist of letters and numbers and can contain up to 16 characters. Symbols, special characters and spaces are not allowed.

1234 EH deactivates access to the internet.

APN with text message

If nothing else is indicated, the software will try to attach 'internet' as APN. If you use another telephone company with another APN, you have to define APN and possibly also user and password (see APN, user and password page 47).

1234 EG NAME-OF-APN defines the APN for the internet connection.

E.g. 1234 EG INTERNET

1234 EG NAME-OF-APN USER CODE defines the APN, user and password for the internet connection.

Create user on the internet via www.profort.dk

- Name/company. Indicate a name, e.g. a company name. This will welcome you to the site.
- User name. It is important that the user name is the same as given in the set-up under settings in the PC program (see 'Username on the Internet' on page 28) or by text message (see).
- Access code. Select an access code. This does not have to be the same as the one of the unit. It may consist of letters and numbers and can contain up to 16 characters. Symbols, special characters and spaces are not allowed.
- E-mail. Indicate an e-mail address. If you forget e.g. your access code, you will be receive it in an email.

Log in to www.profort.com for further help on the Internet administration of the unit.

NB: In order to function on the Internet, it is required that the unit is version 11.05 or later, and that the PC software is version 5.01.01 or later.

12 COMMANDS IN ALPHABETICAL ORDER

Index (alfabetisk list of all commands)

01	11111111	Create receivers in zone	68
2B	11111111	Creates zone 2 in space 11(B)	68
34	11111111	Creates zone 3 in space 4	68
A0		Deletes TEXT on open/break on input 0	69
A0	OPEN/BREAK	TEXT Text on open/break	69
A0	X1	OPEN/BREAK TEXT Create filter and zone:	69
A0	Z1	OPEN/BREAK TEXT Creates zone 1 and TEXT by open/break on input 0	69
A1	<COMMAND>	TEXT	72
A1	<MA>	ALARM Sends the status of inputs with text when input 1 is opened	72
A1	REPEAT	<TP T 0001>	72
A1	TEXT	<COMMAND> Commands in text	72
A1	TEXT	Alarm text is sent in case of exceeding the limit	70
A1	W0	TEXT 'W0' Delays the alarm for 30 sec. for input 1 at opening in zone 0	72
A8	TEXT	Codes the TEXT to be shown at power failure	82
B0		Opens output 0	85
B0	P	Opens output x app. 10 secs	85
B0&1		Output 0 is only opened provided output 1 is already closed/made	73
B8	POWER FAILURE	Answer from unit in case of power failure	82
B9	NO TIME	Message if no clock in unit	82
C1	F	Deactivates pulse or minute counter	70
C1	M	Sets input 1 to minute counter	70
C1	M	xxxxxx Activates count of minutes	70
C1	N	Activates pulse count on input 1	87
C1	N	Resets pulse count on input 1	87
C1	R	States the number of pulses on input 1	87
C1		Sets input1 to be used for pulse count	70
C1	xxxxxx	Activates pulse counting	70
CB		Sends alarms, even though text is not created	75
CF		Sends alarms, although text is not created	75
CF		Sets the unit to send alarm, even though text on input has not been created	72
CN		Sends alarms, although text is not created	75
CN		Sets the unit to send ID and text from inputs where text on input has been created	72
CT		Sets the unit to send created text from detectors	75
CT		Sets the unit to send text from inputs where text on input has been created	72
D1	111111	A TEXT Creates TEXT to be shown at temperature alarm	76
D1	111111	Deletes temperature set-up on detector 111111	76
D1	111111	L TEXT Creates TEXT to be shown when temp. is back in the normal range	76
D1	111111	M Deactivates temperature alarm	76
D1	111111	M z y Activates temperature alarm	76
D1	111111	R States temperature on detector no. 111111	86
D1	111111	S 0 0 Activates temperature measurement in the climaSpot	76
D1	111111	S 1 1 Activates temperature measurement in climaSpot with Profort PTC	77

Commands in alphabetical order

D1	111111	S	-24 70	Activates temperature measurement in flexSpot 111111.....	76
D2	111111	A	TEXT	Creates TEXT to be shown at humidity and other analogue alarms.....	77
D2	111111			Deletes the setup for humidity and other analogue measurement.....	77
D2	111111	K		Deletes factors for volt and mill amperes.....	77
D2	111111	K	z	Defines factors for volt and mill amperes.	77
D2	111111	L	TEXT	Creates TEXT when humidity is within the normal range.....	77
D2	111111	M		Deactivates humidity and other analogue alarm.	77
D2	111111	M	z y	Activates humidity and other analogue alarm	77
D2	111111	R		States humidity or other analog value on detector no. 111111	86
D2	111111	S	0 0	Activates humidity measurement in climaSpot with detector no. 111111.	76
D2	111111	S	2 2	Activates conductivity measurement in climaSpot with wooden block.....	77
D2	111111	S	z y	Activates humidity and other analogue measurement in flexSpot	76
DB				Enables enhanced charging to approx.. 4,1 V.....	74
DE				Deactivates enhanced charging.....	74
DF				Disable power saving mode	74
DM				Collects alarm messages so that several alarms from same digital input or wireless detector only causes one alarm message every 15 mins.....	72
DM				Sends alarm immediately	72
DM				Sends alarm message every 15. mins.	83
DN				Activates power saving mode	74
DS				Sends alarm message immediately.....	83
DT	111111	50	TEXT	the sensitivity of the wireless seismic detector to be 5 and zone to be 075	
DT	111111			Deletes text for detector no. 111111	75
DT	111111	TEXT		Create detector no. 111111 with the chosen TEXT	75
DT	111111	W0	TEXT	the alarm from detector no. 111111 is only sent after 30 secs.....	75
DT	111111	Z1	TEXT	input belongs to zone 1	75
EA	USER	NAME	12345678	Activates access to the internet	78
ED	123456			Sets USER NAME and ID nummber in model LAN	78
EF				Deactivate message at connection/disconnection	81
EG	access_point_name			Defines the APN for the Internet connection	78
EG	APN	user	password	Defines the APN, user and password for the internet connection ...	78
EH				Deactivates access to the Internet	78
EH	USER	NAME		Creates USERNAME in the unit for GPRS access	78
EI	123.456.789.123			Sets the unit for specific IP address by GPRS access	78
EI	SERVER	NAME		Sets the unit for handling on other server by GPRS access	78
EN				Activate message at connection/disconnection.....	81
ES				Disconnects Ethernet on Piccolo Light Server.....	78
ET				Connects ethernet on Piccolo Light Server	78
F2	A			Creates asymmetric filter time.	71
F2				Creates filter time 20 secs.	71
FB				Creates monitoring on low battery level on detectors	75
FE				Deactivates monitoring of low battery on detectors	76
FF				Deactivates monitoring of detectors	75
FN				Creates monitoring of detectors	75
G0				Cancels outputs follow inputs	73

Commands in alphabetical order

G2	Activates (closes) automatic relay outputs at alarm on inputs.....	73
GA	Indicates that outputs follow the corresponding inputs if text has been created	73
H0	Does not activate siren at alarm.....	83
H1	Activates the siren (at alarm on inputs) and sounds for 10 secs.....	83
HF	Deactivates sound signal by activation of wireless detector.....	75
HN	Activates sound signal from the central unit when the wireless detector releases alarm	75
IG 0	Defines output 0 for time control.....	80
IH 0	Deletes time control of output 0.....	80
IU	Deletes time control of all outputs	80
IU HHMM hhmm	Activates an interval for time control of output.....	80
IU HHMM hhmm HHMM hhmm	Activates two intervals for time control of output.....	80
J0	Output 0 changes state (tilts)	85
J3&7	Output 3 changes status (tilts), if output 7 is already closed/made.....	73
JF	does not send alarm in case of power failure.....	83
JM	alarm in case of power failure after 30 mins.	82
JS	In case of power failure, the power alarm is sent immediately	82
K0	Deactivates Send alarm to latest user.	68
K1	Send alarm to latest user	68
K2	Latest user gets alarm as voice message.....	68
K3	Latest user gets alarm both by text messages and as voice message.....	68
KB	Sends alarm via RS232 or GPRS.....	81
KE	Does not send alarm via RS232 or GPRS.....	81
KF	Deactivates 'send acknowledgment' by new command.....	81
KN	Acknowledges each new command	81
KS	Only the first command will be acknowledged	81
L0 CLOSE/MAKE TEXT	Text on close/make.....	69
L0	Deletes text on close/make on input 0.	69
L0 X1 CLOSE/MAKE TEXT	Create filter and zone:	69
L0 Z1 CLOSE/MAKE TEXT	Creates zone 1 and TEXT by close/make on input 0	69
L1 999999	Sets alarm limit=999999 for alarm on counter on input 1	70
L1 STOP REPEAT <TP>	72
L1 W0 TEXT 'W0'	Delays the alarm for 30 sec. for input 1 at closing in zone 0.....	72
L1 xxxxxx	Sets the alarm limit (xxxxxx = 1-999999).....	70
L2 999999	Sets alarm limit=999999 for alarm on counter on input 2	70
L8 TEXT	TEXT to be shown when power is present.	82
L9 TEXT	text shown at sabotage	82
LA TEXT	Creates the TEXT to be shown on the display of the unit.....	82
M1	Deletes macro 1	78
M1 NAME <COMMAND>	Registers macro 1 (M0..M19, (M0-M9 for Remote LAN)) with the name NAME and carries out the command	77
M1 NAME	receive IR codes from a remote control.....	77
MA D1	informs status and performs commands on digital input 1	42
MA	Simulates alarm and activates commands	86
MI heat pump name	Retrieves IR codes for heat pump.....	77
MO	Indicates status of all outputs.....	86

Commands in alphabetical order

MR	Indicates status for inputs with text created.....	86
N0	99999999 Defines the phone number of the unit, e.g. 99999999.....	67
N0	xxxxxxxx yyyy.....	67
N0	xxxxxxxx yyy ID-TEKST.....	67
N1	11111111 Create receiver.....	67
N1	Delete receiver no. 1.....	68
N1	xxx.xxx.xxx.xxx:yyyyy.....	68
N1	xxx.xxx.xxx.xxx:yyyyy Space No. 1, sends alarm as SIA-IP protocol to a control center. 68	68
N2	11111111 # Creates alarm receiver-voice.....	67
N3	11111111 * Creates alarm receiver-DTMF.....	67
N4	200 aaaa@bb.com Creates email address.....	68
N4	999 aaaa@bb.com Creates e-mail address (e.g. aaaa@bb.com) to send alarm.....	68
N5	11111111 + Approved numbers.....	68
NAME	<COMMAND> Registers macro 1 (M0..M19, (M0-M9 for Remote LAN)) with the name NAME 77	
NAME	Activates the macro named NAME.....	78
NO	321 Order of numbers.....	68
NO	TIME Text when own number is missing and clock is activated.....	82
NR	Deletes changed order of numbers.....	68
OA	10 Activates limited disconnection for 1-30 mins.....	84
OA	Deactivates limited disconnection.....	84
OF	Disconnects the unit.....	84
OF	Z1 Disconnects zone 1.....	84
OG	States GPS position.....	86
OK	States signal strength on the GSM net.....	86
OM	States the version number (model) of the unit.....	86
ON	Connects the unit.....	84
ON	Z1 Connects zone 1.....	84
OP	States position (GSM cell-ID and distance).....	86
OR	Informs status on connection/disconnection.....	86
OS	shows which detectors are active.....	84
OV	After eight minutes the status of the detectors is sent.....	84
P-	Deletes the setup in the unit.....	87
P!	BEWARE – Deletes all! Restores unit to default settings.	83
P#	Delete all calendar settings.....	81
P#	Deletes calendar settings.....	87
P%	Deletes analogue measurements.....	87
P&	Deletes event log.....	87
P/	Deletes all wireless remote controls created.....	87
P/	Deletes setup and reinstalls default setup.....	87
P0	Output 0 changes stage (pulses).....	85
P0	Sets output 0 to pulse (One shot).....	73
P1&0	Output 1 will be pulsed if output 0 is already closed/made.....	73
PA	DDMMYY DDMMYY Returns analogue measurements to the PC-program.....	86

Commands in alphabetical order

PA DDMMYY	Transfers analogue measurements from date, month, year.....	86
PA	Returns analogue measurements to the PC-program.....	86
PA xx	Returns analogue measurements to the PC-program.....	86
PL 20	States the last 20 events in the log.....	86
PL A	States all events in the log.....	86
PL	States the last 10 events in the log.....	86
PR I	States IR codes installed.....	86
PR K	Returns all activities in the calendar to the requestor.....	81
PR K	States all activities in calendar.....	87
PR M	States all macros and associated command names.....	86
PR N	States the receiver list.....	86
PR O	States set-up of inputs and outputs.....	86
PR	States all of the unit set-up.....	86
PR T	States all texts on inputs in the.....	86
PS 10	Pauses between commands for 10 secs.....	85
Q1	Reverses pulse length (P0) to 10 secs.....	73
Q2	Sets pulse length (P0) to 20 secs.....	73
QF	Relays do not show state of zones.....	73
QN	Sets the output to show the state of zones.....	73
RF	Input for connection/disconnection.....	69
RN	Input for connection/disconnection.....	69
RO 1100 <MA D1>	Sends alarm for missing activity.....	86
RP	Input for connection/disconnection.....	69
S0	Closes output 0.....	85
S0 P	Closes output x app. 10 secs.....	85
S0&2&4&7&5	Output 0 is only closed/made provided outputs 2, 4, 7 and 5 are all closed/made	73
S8 POWER OK	Answer when power is present.....	82
S8 TEXT	Answer from unit when power is present sent to receivers in zone 0.....	83
S9	Answer when sabotage, sent to receivers in zone 0.....	82
T0	Stops/deactivates the timer.....	79
T1	Codes the timer to activate 1 time.....	79
TA 9999	Change password in wireless unit.....	75
TF	Deletes clock from the unit.....	79
TI 0800 1600	Creation of automatic connection and disconnection.....	80
TI	Deletes settings for automatic connection and disconnection.....	80
TK	Deletes user password.....	67
TK xxxx	Creates user password.....	67
TL 1234 111111 ALARM	Wireless alarm from e.g. detector no. 111111.....	75
TM	Automatically creates the clock in the unit.....	78
TM YY/MM/DD, HH:MM:SS	Creates clock in the unit manually.....	79
TP D	status daily	79
TP M	status after minutes.....	79
TP P	Read counter daily and reset.....	79
TP T	status every 15. mins.....	79
TP W 1200 <xx; zz>	Execute command xx and zz weekly at 1200 hrs.....	79

Commands in alphabetical order

TP W	status on all inputs weekly	80
TR	Returns the time of the unit.....	79
TS D HHMM	<COMMAND; COMMAND> Execute command(s) every day at hhmm.....	81
TS D HHMM	Delete daily activity	81
TS DDMMYY HHMM	<COMMAND; COMMAND> Calendar, specific date	81
TS DDMMYY HHMM	Delete specific activity.....	81
TS F HHMM	<COMMAND; COMMAND> Execute command Fridays	81
TS L HHMM	<COMMAND; COMMAND> Execute command Saturdays (L).....	81
TS M HHMM	<COMMAND; COMMAND> Execute command Mondays.....	81
TS O HHMM	<COMMAND; COMMAND> Execute command Wednesdays (O).....	81
TS R HHMM	<COMMAND; COMMAND> Execute command Thursdays (R).....	81
TS S HHMM	<COMMAND; COMMAND> Execute command Sundays	81
TS T HHMM	<COMMAND; COMMAND> Execute command Tuesdays.....	81
TS x HHMM	Delete weekly activity (x = M, T, O, R, F, L, S)	81
TU	Sets the timer to run indefinitely.....	79
UF	Deactivates pulse or minute counter on input 1	70
UL	States the number of pulses on input 1	87
UM	Activates minute counter on input 1	70
UN 999999	Activates counter on input 1	70
UN	Activates and resets pulse counter on input 1	70
UN	Resets pulse count on input 1	87
V1 A LOW TEXT	Low alarm text on analogue input 1	70
V1 A X1 LOW TEXT	Creates filter on analogue input 1 in zone 1.....	71
V1 A Z1 LOW TEXT	Zone on analogue alarms.....	71
V1 B HIGH TEXT	High alarm text on analogue input 1	71
V1 B X1 HIGH TEXT	Creates filter on analogue input 1 in zone 1	71
V1 B Z1 HIGH TEXT	Zone on analogue alarms	71
V1 L MEDIUM TEXT	Medium alarm text on analogue input.....	70
V1 L X1 MEDIUM TEXT	Creates filter on analogue input 1 in zone 1.....	71
V1 L Z1 MEDIUM TEXT	Zone on analogue alarms	71
V1 M yyyy zzzz	Setting up values for the normal interval	70
V1 P -0,5	Alarm when percentage deviation.....	71
V1 R	States the latest measurement from analog input 1	86
V1 S yyyy zzzz	Set up of the scale on analogue 1	70
VF	Stops sending of signal strength to.....	76
VP	Shows signal strength and type of data well as measurements on climaSpot and luxSpot.....	76
VT	Signal strength, number and texts on wireless detectors	76
WF	Sets inputs to activate at GND	74
WN	Sets inputs to activate at 24 V.....	74
X9	Indicates 9 secs. (from 0-9) from telephone connection is established to the first DTMF-tone or voice message is sent	71
YF	Sabotage/power alarms are not sent when the system is disconnected	82
YF Z1	Sabotage/power alarms from zone 1 are not sent when zone 1 is disconnected	82
YN	Sabotage/power alarms are also sent when the system is disconnected	82
YN Z1	Sabotage/power alarms from zone 1 are also sent when zone 1 is disconnected.....	82

13 VOICE MESSAGES

(Only applies to units with voice memory.)

The unit has 90 sec. voice memory and will always first play the general message (three seconds.) followed by the actual alarm message (three seconds).

The receiver may acknowledge a voice message with #. This should take place immediately after playing the voice message and the sound of the 'beep'. If this does not happen, the unit will continue to the next receiver on the list. When a receiver acknowledges with # during the playback of the voice message, the receiver list is interrupted, and further alarms are called off.

You may record messages for both digital and analog inputs, system alarms as well as wireless detectors. To get voice messages from the wireless detectors, the detectors must be created in zones. The zones release alarms from corresponding inputs, e.g. zone 1 is the same message as input 1, zone 2 as input 2, etc.

13.1 Record voice message

NB! It is important that the unit is within earshot whilst programming, since you have to wait for a 'beep' of acknowledgment from the unit when recording messages!!!

1. Call the unit and await one or two tones
2. If one tone is heard, then type password (e.g. 1234). In case of wrong password the unit disconnects and you have to call again
3. If two tones are heard, the password is correct or the SIM card PIN code is deactivated
4. Enter '#' and the number of the message you want to record, e.g. #8 (for general message). See additional codes in the table below
5. Await 1 tone from the telephone and after approx. 3 secs. a 'beep' from the unit
6. Record message of max. 3 secs. After 6 secs. the unit emits a 'beep' and the message is saved
7. Wait an additional 6 secs. and two tones are heard
8. The message has now been recorded and the call may be ended or a new voice message recorded, e.g.:
9. Enter #1 (voice message for input 1)
10. Await a tone from the telephone and after approx. 3 secs. a 'beep' from the unit
11. Record a message of max. 3 secs. After 6 secs. a 'beep' is heard from the unit and the message is saved
12. Wait an additional 6 secs. and two tones are heard from the telephone
13. Repeat step 9-12 for more messages
14. Hang up

Important:

Programming cable (SubD RS 232 plug) must not be connected whilst recording and/or testing voice messages!

When a voice message is received, you'll hear the general message first and after an additional 5 secs. the individual message is heard (from digital input, analog input or a basic alarm). If only general message has been recorded, this will be played twice.

Voice messages

The receiver can acknowledge a voice message with #. This must be done immediately after playback of the last message and tone from the telephone. If this isn't done, the unit will continue to the next receiver on the list.

13.2 Duration of voice messages

Codes for recording of voice messages		Analogue inputs	
#8 General message	3 secs.	#91: analogue input 1	3 secs.
Digital inputs		#92: analogue input 2	3 secs.
#0 for input 0	3 secs.	System alarm	
#1 for input 1	3 secs.	#94: power failure	3 secs.
#2 for input 2	3 secs.	#95: power ok	3 secs.
#3 for input 3	3 secs.	#96: sabotage	3 secs.
#4 for input 4	3 secs.	#97: connection (command EN)	3 secs.
#5 for input 5	3 secs.	#98: disconnection (command EF)	3 secs.
#6 for input 6	3 secs.		
#7 for input 7	3 secs.		

14 Log

The unit saves the information from monitoring in a data log and an event log, respectively. They may be seen in the PC Program (needs the Basis Setup as a minimum) or on the unit display (for units with display).

14.1 Event log

The event log contains between 256 and 999 events, depending on the model. An event is e.g. a command given, an alarm or a status message.

See event log in the PC program

(Requires the Profort pc program with basis setup as a minimum.)

The event log in the PC Program can be read in the inbox on the main page. If the inbox is not visible, you may find it under Files → Show inbox. The box contains different information received by the unit. To see the event log you must therefore request that it is sent to you.

Press 'Send inquiry' on the main page. Ask for a 'Return log'. This can be done in two ways; either tick 'Send', and get a log of the 10 latest events, or you can choose how many events you want it to show by writing the desired number in the field before 'Send' (see e.g. Figure 10-1: page 87).

The event log can now be read in the inbox:

Figure 14-1

Inbox			
Time	Transmitter	Description	Message
06-09-2010 08:31:13	+4523869975	KFA-Hjem	OK>> PR OF:KF:CT:YN:JS:TM
06-09-2010 08:31:18	+4523869975	KFA-Hjem	OK>> PR M4 TEMP <V1 R>
06-09-2010 08:31:23	+4523869975	KFA-Hjem	OK>> PR M5 PIR FRA <TI:OF:UF>
06-09-2010 08:31:27	+4523869975	KFA-Hjem	OK>> PR M6 PIR 8 <UF:ON:TI 0800 1530>
06-09-2010 08:31:32	+4523869975	KFA-Hjem	OK>> PR M7 PIR TIL <UF:ON:TI>
06-09-2010 08:31:37	+4523869975	KFA-Hjem	OK>> PR M8 ALARM <SO:PS 10:B0:UF>
06-09-2010 08:31:42	+4523869975	KFA-Hjem	OK>> PR M9 PIR KLAR <UF:OF:TI 0800 1530>
06-09-2010 08:31:46	+4523869975	KFA-Hjem	OK>> PR N0 23869975 0000 HJEM
06-09-2010 08:31:51	+4523869975	KFA-Hjem	OK>> PR N1 30224956
06-09-2010 08:32:16	+4523869975	KFA-Hjem	OK>> PR 72 30224956 *
06-09-2010 08:32:21	+4523869975	KFA-Hjem	OK>> PR N3 30224956 #
06-09-2010 08:32:26	+4523869975	KFA-Hjem	OK>> PR V1 M 0015 0063
06-09-2010 08:32:31	+4523869975	KFA-Hjem	OK>> PR V1 S -132 0063
06-09-2010 08:32:37	+4523869975	KFA-Hjem	OK>> PR V1 A ALARM TEMP. GRADER:
06-09-2010 08:32:41	+4523869975	KFA-Hjem	OK>> PR V1 L NORMAL TEMP. GRADER:
06-09-2010 08:32:46	+4523869975	KFA-Hjem	OK>> PR A1 PIR ALARM

The inbox can be printed in Files → Print inbox. The print can be sorted by date or sender. This way it is possible to print the event log.

The inbox can be hidden again from the main page in Files > Show inbox.

Log

See event log in Web browser <http://setup.masterview.dk>

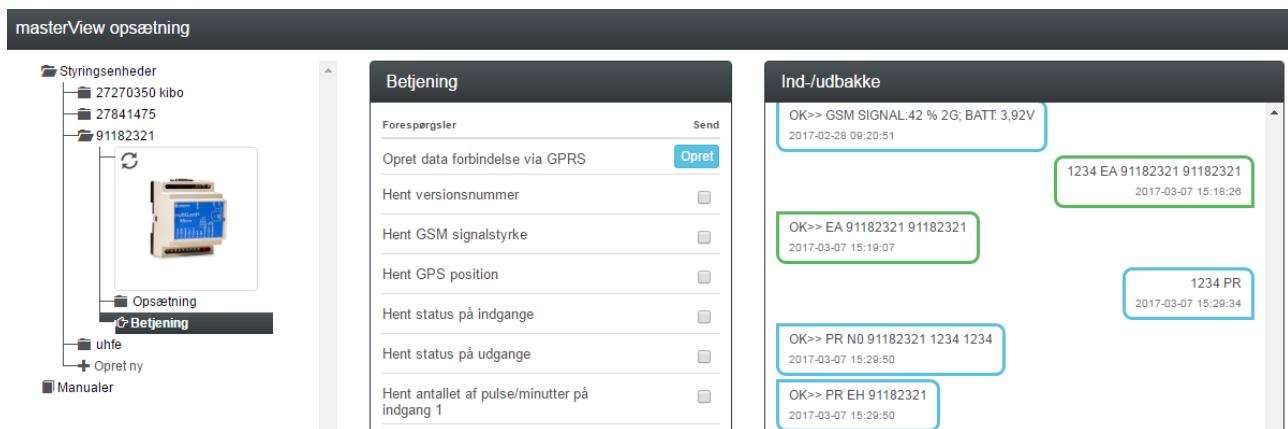

Under betjening vises Ind-/udbakke ved to ramme farver
Grøn: SMS trafik (ved opretning af ny enhed). Ud i højre halvdel. Ind i venstre halvdel.
Blå: Data trafik efterfølgende. Ud i højre halvdel. Ind i venstre halvdel.

See event log in display

(For units with display)

The log shows the latest events (up to 999), e.g. alarms, warnings, CONNECTION/DISCONNECTION and programming.

1. Press Menu
2. Press LOG
3. Press ALARMS

Use the UP and DOWN keys to navigate up and down the list. A whole page changes when you press UP or DOWN.

If the timer function is not activated, the log will not show the time of the alarm (date/time). Only the alarm number in the history, e.g.:

```
001 S9 SABOTAGE
002 [serial no.] TEXT
```

If the timer function is activated, the display will show the time of the alarm (date/time), e.g.:

```
01/16/05 1038
```

The history is shown chronologically.

Notice that if the unit is set to only send alarm if text has been created, then you will only see the text defined detectors.

See event log with text messages

1234 PL	States the last 10 events in the log. I.e. incoming alarms/data and commands sent. NB: Returned with one event in each text message = 10 texts
1234 PL 4	States the latest 40 events in the log. I.e. incoming alarms/data and commands sent. NB: Returned with one event in each text message = xxx texts

Log

1234 PL A	States all events in the log (256 lines). I.e. incoming alarms/data and commands sent. NB: Returns with one event in each text message = up to 999 texts
-----------	---

14.2 Data log

The data log in the unit holds 24,576 or 150,000 measurements depending on the unit. Data is collected from a wireless detector each 4 minutes, and two measurements per hour are registered. This gives room for e.g. approx. eight years of measurements from a measuring point, two years for two points, etc. if the unit holds 150,000 measurements.

You can create 32 or 64 measuring points as a maximum depending on the model. A climaSpot takes up two measuring point when both temperature and humidity are activated. The wired analog inputs count as measuring points when they are activated. When the log is full, the oldest posts are overwritten.

The clock must be set in the unit before the data log can be used.

See data log in the unit display

(For units with display)

1. Press Menu
2. Press LOG
3. Press MEASUREMENTS

Use the UP and DOWN keys to navigate up and down the list. A whole page changes when you press UP or DOWN.

Note: Measurements are dynamically updated every minute. Red numbers indicate that the value is outside of the programmed medium range of the interval.

Transfer data log from unit to pc

(Requires the Basis Setup as minimum.)

In order to transfer the data log from the unit to a PC, they have to be connected by a RS232 cable or via the Internet).

- Open the Profort pc program Basis setup
- Press 'Send inquiry' → Mark the field 'Return analogue data' (see figure 14-2)
- The unit will now transfer all measurements from wireless and wired measuring tools if they have been created with text
- When 'Measurements are received' in the bottom of the window disappears, the log has been transferred to the PC. This may take a few minutes.

Log

Figure 14-2

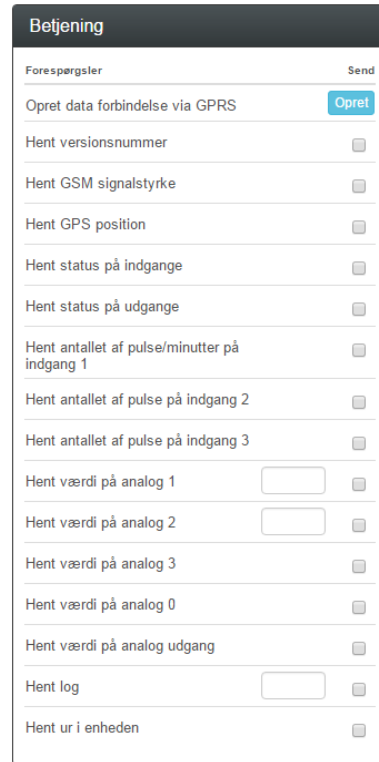
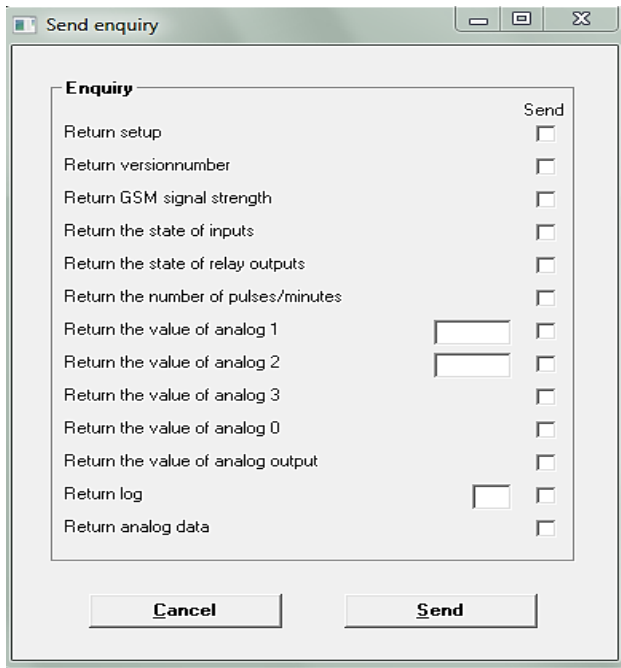

Read log

Select 'Files' → 'Analogue measurements'. Select search criteria and press 'Show'.

Figure 14-3

Unit	Description	Detector	Description	Text 1	Text 2	Time	Analog 1	Analog 2
131	Ny Mohr	31116	STALD 3	OK TEMP	ALARM FUGT	24-08-10 18:00	17,6	88,9
131	Ny Mohr	31116	STALD 3	OK TEMP	ALARM FUGT	24-08-10 18:30	17,6	85,0
131	Ny Mohr	31116	STALD 3	OK TEMP	ALARM FUGT	24-08-10 19:00	17,0	86,8
131	Ny Mohr	31116	STALD 3	OK TEMP	ALARM FUGT	24-08-10 19:30	17,0	88,0
131	Ny Mohr	31116	STALD 3	OK TEMP	ALARM FUGT	24-08-10 20:00	17,0	88,0
131	Ny Mohr	31116	STALD 3	OK TEMP	ALARM FUGT	24-08-10 20:30	17,0	88,0
131	Ny Mohr	31116	STALD 3	OK TEMP	ALARM FUGT	24-08-10 21:00	16,7	85,3
131	Ny Mohr	31116	STALD 3	OK TEMP	ALARM FUGT	24-08-10 21:30	16,7	83,9
131	Ny Mohr	31116	STALD 3	OK TEMP	ALARM FUGT	24-08-10 22:00	16,7	83,9
131	Ny Mohr	31116	STALD 3	OK TEMP	ALARM FUGT	24-08-10 22:30	16,7	85,3
131	Ny Mohr	31116	STALD 3	OK TEMP	ALARM FUGT	24-08-10 23:00	16,7	85,3
131	Ny Mohr	31116	STALD 3	OK TEMP	ALARM FUGT	24-08-10 23:30	16,7	85,3
131	Ny Mohr	31116	STALD 3	OK TEMP	ALARM FUGT	25-08-10 00:00	16,7	84,4
131	Ny Mohr	31116	STALD 3	OK TEMP	ALARM FUGT	25-08-10 01:00	16,7	85,3
131	Ny Mohr	31116	STALD 3	OK TEMP	ALARM FUGT	25-08-10 01:30	16,7	86,5
131	Ny Mohr	31116	STALD 3	OK TEMP	ALARM FUGT	25-08-10 02:00	16,6	86,1
131	Ny Mohr	31116	STALD 3	OK TEMP	ALARM FUGT	25-08-10 02:30	16,7	86,9
131	Ny Mohr	31116	STALD 3	OK TEMP	ALARM FUGT	25-08-10 03:00	16,7	86,9
131	Ny Mohr	31116	STALD 3	OK TEMP	ALARM FUGT	25-08-10 03:30	16,7	84,4
131	Ny Mohr	31116	STALD 3	OK TEMP	ALARM FUGT	25-08-10 04:00	16,6	81,8
131	Ny Mohr	31116	STALD 3	OK TEMP	ALARM FUGT	25-08-10 04:30	16,6	81,8
131	Ny Mohr	31116	STALD 3	OK TEMP	ALARM FUGT	25-08-10 05:00	16,6	79,1
131	Ny Mohr	31116	STALD 3	OK TEMP	ALARM FUGT	25-08-10 05:30	16,6	78,6
131	Ny Mohr	31116	STALD 3	OK TEMP	ALARM FUGT	25-08-10 06:00	16,6	78,6
131	Ny Mohr	31116	STALD 3	OK TEMP	ALARM FUGT	25-08-10 06:30	16,6	78,1

When you are done with the log, you have to finish with 'Ok' to close the window and return to the main page. Or you can choose to press 'Export' to save the log as a .csv file. A .csv file can be further processed in e.g. MS Excel.

If you type 'Presentation', data will be transferred to Excel and shown in a diagram. This requires that Excel has been installed on the PC.

15 IR CODES

IR remote control can record and play infrared signals e.g. from a remote control. The infrared code is recorded as a macro and can be played by phoning the device, sending a text message, activation by login at www.profort.com, or as command through the PC Program.

Other models with IR sender need to have IR codes transferred via PC Basic from a '.csv-file' which can be downloaded from the Profort webpage.

Record IR code with the Profort pc program

1. Prepare the remote control of the heat pump to ship the desired function
2. Open the Profort PC Program, click on 'Setup', and select the tab 'More'
3. Navigate to the Macros (A4)
4. Type a name of the function in the 'Macro name' e.g. HEAT8 (see Figure 15-1)
5. Press 'Send/Save' (or 'Execute' in Quick setup')
6. The LED lamp of the unit flashes quickly for 30 secs. Point the remote control of the heat pump at the device and activate the desired function. The LED lamp turns off when a valid IR code is received.

The IR-code is now stored in the device. In order to save the code in the PC application you must upload the set-up from the device to the program. On the main page press 'Send inquiry' > 'Return setup'. The IR-codes will now be transferred and stored in the Profort PC program.

Figure 15-1

Macros	
Macro name	Commands
0 TEMP	V1 R
1 HEAT8	R1

Record IR code with text message

1. Set the desired options on the remote control
2. Send a text message with the command 1234 M1 NAME or the first 2-3 letters of the name of the heat pump. The codes are hereby retrieved from the pre-programmed codes in the heat pump controller (v.12.08)
3. Macro 1 (M0..M9*, M0..M9+R0..R9) with the name NAME is now being prepared
4. When the red diode of the device flashes quickly: turn the remote control towards "IR-in" at the device and press the desired function within the next 30 secs.
5. The diode lights up briefly and then flashes normally. Now macro x is saved with an infrared code and the name NAME

The IR code is saved in the device. See above how to transmit the information to Profort PC application.

*) Not all units contain 20 macros

IR codes

Archive for IR codes

The Profort PC Program has an archive for infrared codes (Figure 15-2). It requires as a minimum the Profort PC Program with Basis setup.

The archive can be found at the top of the main page (Figure 5-4) under Project > Infrared codes.

Figure 15-2

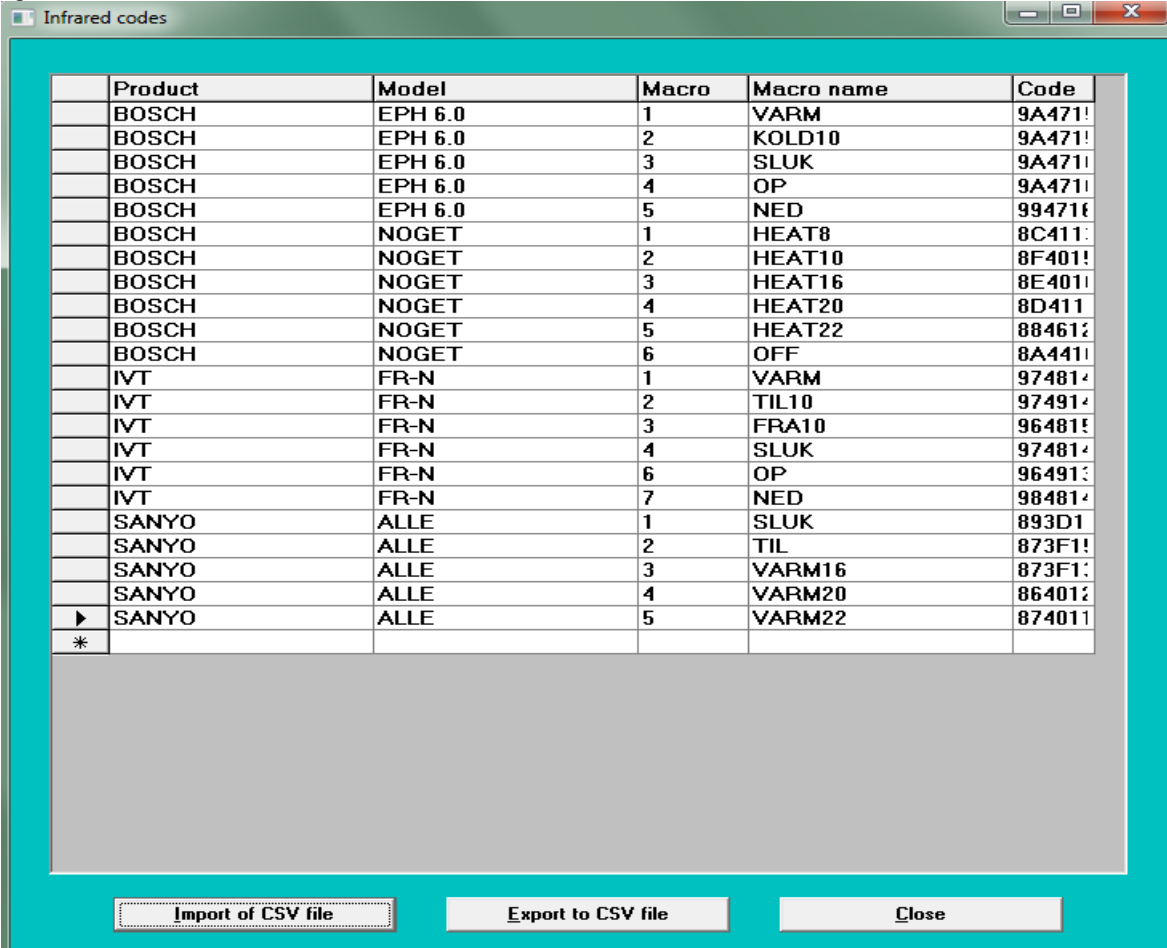

	Product	Model	Macro	Macro name	Code
	BOSCH	EPH 6.0	1	VARM	9A471!
	BOSCH	EPH 6.0	2	KOLD10	9A471!
	BOSCH	EPH 6.0	3	SLUK	9A471!
	BOSCH	EPH 6.0	4	OP	9A471!
	BOSCH	EPH 6.0	5	NED	99471!
	BOSCH	NOGET	1	HEAT8	8C411!
	BOSCH	NOGET	2	HEAT10	8F401!
	BOSCH	NOGET	3	HEAT16	8E401!
	BOSCH	NOGET	4	HEAT20	8D411!
	BOSCH	NOGET	5	HEAT22	88461!
	BOSCH	NOGET	6	OFF	8A441!
	IVT	FR-N	1	VARM	97481!
	IVT	FR-N	2	TIL10	97491!
	IVT	FR-N	3	FRA10	96481!
	IVT	FR-N	4	SLUK	97481!
	IVT	FR-N	6	OP	96491!
	IVT	FR-N	7	NED	98481!
	SANYO	ALLE	1	SLUK	893D1!
	SANYO	ALLE	2	TIL	873F1!
	SANYO	ALLE	3	VARM16	873F1!
	SANYO	ALLE	4	VARM20	86401!
	SANYO	ALLE	5	VARM22	87401!
	*				

It is possible to archive the IR codes from Profort PC Program or to import external IR codes from a .csv file to the archive. The archive can conversely also be exported to a .csv file, so that the IR codes can be stored for later use.

The Profort PC application can either send the codes from the program to archive or you can load codes from the archive into the software so that you don't have to record the code yourself.

Send infrared codes to archive

Go to the main page of the Profort PC program and press the bottom 'Setup'. Find the tab 'more' and the area of 'Macros' (V4).

Press the button 'Send infrared codes to archive' and enter the manufacturer and model of the object that matches the IR codes e.g. Bosch EPH 6.0 heat pump.

The codes are now sent from the set-up to the archive in the PC Program.

Retrieve infrared codes from archive

If any IR codes previously have been archived either by record or download, they can be retrieved from the archive by pressing the button 'Retrieve infrared codes from archive' in territory V4 (see above).

Select from which manufacturer and model you want to download IR codes. Manufacturer and model are shown only when IR codes are stored in the archive.

When you press 'Send/Save' you transfer the set-up to the unit and save the codes in there..

See more about IR in setup on page 47.

Export IR codes

IR codes can be extracted from the Profort PC Program and saved for later use by exporting them to a .csv file.

1. Open the archive with the IR codes (see above about the archive)
2. Press the 'Export to CSV file'
3. Select a location on your computer where you want to save the codes
4. The IR codes from the archive are now stored outside the Profort PC program

Import IR codes

If you are in possession of a .csv file with IR codes you can import it into Profort PC Program and transmit it to a device. Hence you do not need to record the codes yourself.

1. Open the archive with the IR codes (see above about the archive)
2. Press 'Import of CSV-file'
3. Locate the desired file on your computer and open it
4. The new IR codes are now retrieved into the archive in Profort PC Program, and can be transferred to a device (see 'Retrieve infrared codes from archive' above if needed).

At www.profort.com a .csv file with IR codes for different heat pumps is saved under **DOWNLOAD** by models with infrared. Save the file on your computer, and it is ready to be imported to the archive in Profort PC Program.

Frequently asked questions

16 FREQUENTLY ASKED QUESTIONS

Error	Cause	Solution
The unit 'beeps' quickly at start-up	A wrong PIN code has been used on the SIM card	Set the PIN code of the SIM card to 1234 and restart the unit
The unit 'beeps' app. each 15 secs.	No connection to the SIM card	The SIM card has a defect or has been incorrectly inserted
The red LED of the unit flashes three times	The mobile number of the unit itself has not been indicated correctly	Indicate correct mobile no. or remove status or timer functions
After four beeps, the unit flashes twice	The SIM card has not been inserted, or has been incorrectly inserted in the unit	Check if the SIM card has been correctly inserted in the unit
	The unit has no contact to the internet	Check if the SIM card functions correctly, or if the unit has been set up with all parameters for the Internet
The unit cannot send an alarm.	The SIM card is not functioning	Put the SIM card in a mobile phone and check if you can send and receive text messages
	No voltage on the unit	Check whether the green LED is lit. If this is not the case, a correct power supply must be used
	Wrong receiver number	Check if the correct receiver telephone no. has been used, and if a mobile telephone no. has been used for text message
	Text definition	Check if the unit has been set up to send only alarms whose input is text defined
	Unit is not connected	Check if the red LED flashes. If this is the case, the unit is either connected by input #0 or text message
	No GSM coverage	Connect the unit to PC and send the command 'OK' or see bottom of the display. GSM signal strength is returned and shall be higher than 25%
	Inputs are divided into zones with no texts indicated	If zone division is used, a text should always be indicated on the inputs used
Disconnection and connection of the central unit does not work from input 0.	Wrong set-up	If input 0 is to be used for disconnection and connection, the command 'RP' shall be used, if input 0 is activated by a pulse.

Frequently asked questions

The unit timer function does not work	Wrong GSM number	If input 0 is activated by a level, 'RN' is used Indicate correct GSM No. on the SIM card to the unit
The unit status function does not work	Wrong GSM number	Indicate correct GSM No. on the SIM card to the unit
Sends the text message NO TIME when the text A9 NO TIME is used	Wrong or missing GSM number	Indicate correct GSM No. on the SIM card to the unit
Power alarm is not sent when external power is removed	Battery does not work	Notice that rechargeable batteries must be used. Either the battery is defect, or it has not yet been sufficiently charged
Unable to establish contact to the unit via PC	Default is 'Send power alarm after 30 mins.'	Change to 'Send power alarm immediately' with PC Program or text message "1234 JS"
Unable to establish contact to the unit via PC	RS232 connection between PC and central unit is defective	Check if the connection between central unit and PC has been correctly mounted Check if cable is intact and has connection in all nine conductors Check if the PC software uses the correct COM-port
Unable to establish contact to the unit via PC	Unit does not reply to set-up	A wrong password is used for the unit. Remove the SIM card from the unit, insert it into a mobile phone and change the password to 1234. Remember that the PIN code must be activated
Unable to establish contact to the unit via PC	Unit is busy	Check whether the red LED is lit. If this is the case, the unit is busy. Wait till the red led shuts off or restart the unit
Error message 'Installation error' is shown	LED is constantly on, and SIM card has not been mounted. The detector in question has not been correctly installed	Activate alarm on any input Check if the physical surroundings disturb the performance of the detector (e.g. light, air flows, concrete), battery in detector and possibly adjust sensitivity of the seismic detector